

Kodak EasyShare CX6445 zoom digital camera



User's Guide

www.kodak.com

For interactive tutorials, www.kodak.com/go/howto

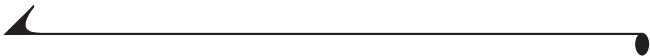

Eastman Kodak Company
343 State Street
Rochester, New York 14650
© Eastman Kodak Company, 2004

All screen images are simulated.

Kodak, EasyShare, and Max are trademarks of Eastman Kodak Company.

P/N 4J1320

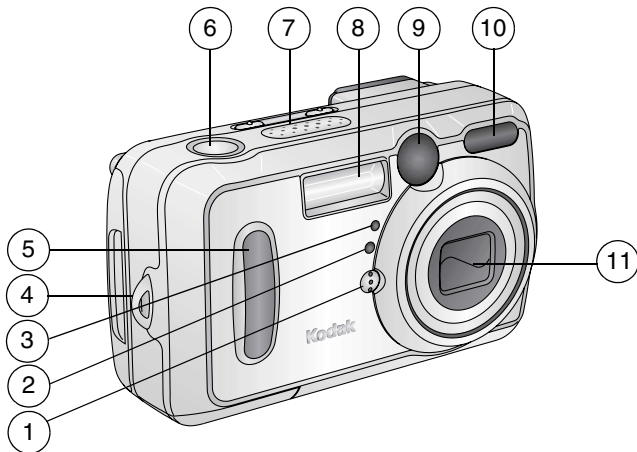

Front View

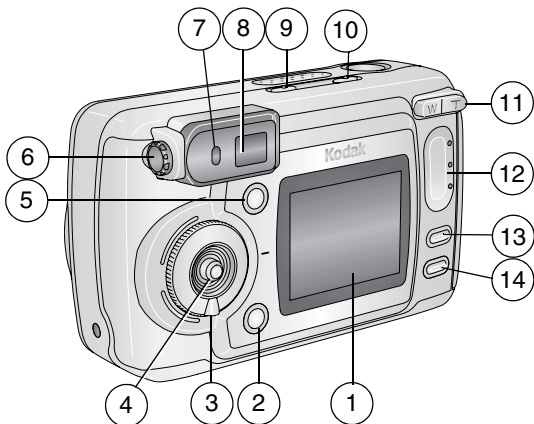

- | | | | |
|---|------------------------|----|-------------------|
| 1 | Microphone | 6 | Shutter button |
| 2 | Light sensor | 7 | Speaker |
| 3 | Self Timer/Video light | 8 | Flash unit |
| 4 | Wrist strap post | 9 | Viewfinder lens |
| 5 | Grip | 10 | Auto focus sensor |
| | | 11 | Lens |

Back View



- | | | | |
|---|---|----|---|
| 1 | Camera screen
(LCD, liquid crystal display) | 7 | Ready light |
| 2 | Share button (page 55) | 8 | Viewfinder |
| 3 | Mode dial/Off (page 16 , page 5) | 9 | Self Timer/Burst button  |
| 4 | Joystick (Move )
OK button (Press in) | 10 | Flash/Status button  |
| 5 | Delete button | 11 | Zoom (Wide Angle/Telephoto) |
| 6 | Diopter dial | 12 | Grip |
| | | 13 | Menu button |
| | | 14 | Review button |

Side Views

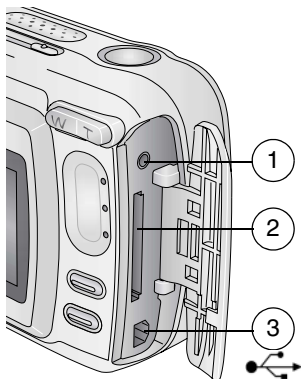

Left Side

- 1 A/V Out, for television viewing
- 2 Slot for **optional** SD/MMC card
- 3 USB Port 

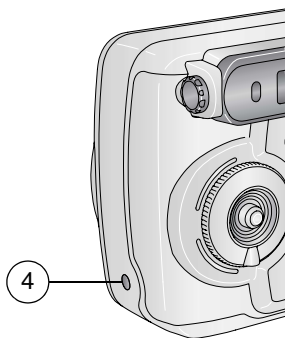



Right Side

- 4 DC-In (3V) ,
for **optional** AC adapter

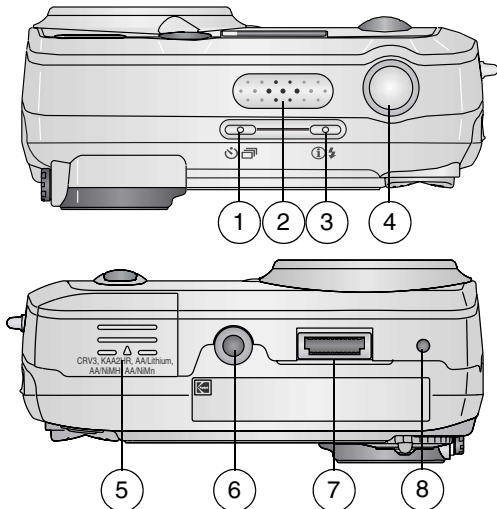
Top and Bottom Views



Top

- 1 Self Timer/Burst button 
- 2 Speaker
- 3 Flash/Status button 
- 4 Shutter button

Bottom

- 5 Battery door
- 6 Tripod socket/locator, dock 6000
- 7 Dock connector
- 8 Locator, dock 6000

Table of Contents

1	Getting Started	1
	Install Software First.....	1
	Need This Guide in Larger Print?.....	1
	What Can I Do With My Camera?.....	2
	What Can I Do With My Pictures and Videos?.....	2
	Package Contents.....	3
	Loading the Battery.....	4
	Attaching the Wrist Strap	4
	Turning On the Camera.....	5
	Setting the Date and Time	6
	Checking Camera Status.....	7
	Camera Screen Icons	8
	Inserting an SD/MMC Card	9
	Choosing Internal Memory or SD/MMC Card.....	10
	Important Battery Information.....	12
2	Taking Pictures	15
	Take a Picture	15
	Picture-Taking Modes	16
	Liveview—Framing with the Camera Screen.....	17
	Quickview—Reviewing the Picture Just Taken	19
	Adjusting the Viewfinder	19
	Using the Optical Zoom	20
	Using the Advanced Digital Zoom.....	20

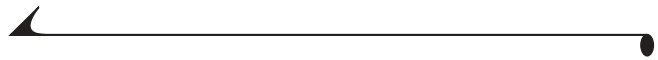

Using the Flash.....	21
Putting Yourself in the Picture.....	23
Taking a Burst Series of Pictures	24
Changing Optional Settings	25
Setting Exposure Compensation	27
Setting Picture Quality.....	28
Setting Color Mode	29
Setting White Balance	30
Setting ISO Speed.....	31
Setting Long Time Exposure.....	32
Setting Exposure Metering	33
Setting Focus Zone.....	34
Pre-tagging for Album Names	35
Placing the Date on Pictures	36
Setting the Orientation Sensor.....	37
3 Taking Videos	39
Taking a Video.....	39
Quickview—Reviewing the Video Just Taken.....	40
Using the Optical Zoom.....	41
Changing Optional Video Settings.....	41
Pre-tagging for Album Names	42
Putting Yourself in the Video	43
4 Reviewing Pictures and Videos	45
Viewing Single Pictures and Videos	45
Viewing Multiple Pictures and Videos.....	46

Playing a Video.....	46
Deleting Pictures and Videos.....	47
Changing Optional Review Settings	48
Magnifying Pictures	48
Protecting Pictures and Videos From Deletion.....	49
Tagging Pictures/Videos for Albums.....	50
Running a Slide Show	51
Displaying Pictures/Videos on a Television	52
Copying Pictures and Videos.....	53
Displaying Video Date.....	54
Viewing Picture/Video Information	54
5 Sharing Pictures and Videos	55
When Can I Tag My Pictures and Videos?.....	55
Tagging Pictures for Printing.....	56
Tagging Pictures and Videos for Emailing.....	57
Tagging Pictures and Videos as Favorites	58
Need Help?	58
6 Customizing Your Camera Settings	59
To Access Setup Mode/Menus	59
Setup Menus.....	59
Changing the Default Print Quantity	60
Turning Off Quickview	60
Turning On Liveview in Still Modes	61
Changing Advanced Digital Zoom	62
Turning Off the Shutter Sound	62

Setting Video Out.....	63
Selecting a Language	63
Formatting Internal Memory or SD/MMC Card.....	64
Viewing Camera Information	64
7 Installing the Software	65
Minimum system requirements.....	65
Install the Software.....	66
8 Connecting Camera to Computer	69
Transferring Pictures With the USB Cable	69
Printing Pictures from Your Computer	70
Printing From an Optional SD/MMC Card.....	70
Print With or Without a Computer.....	70
9 Using the Camera Dock 6000	71
Camera Dock 6000 Package Contents	71
Installing the Custom Camera Insert.....	72
Connecting the Camera Dock 6000.....	73
Installing the Rechargeable Battery.....	74
Docking the Camera	75
Charging the Battery	76
Transferring Pictures With the Dock	77
Reviewing Pictures and Videos	78
Camera Dock 6000 Specifications	78
Troubleshooting—Camera Dock 6000	79
Earlier Cameras and Docks	80

10	Troubleshooting	81
	Camera Problems.....	81
	Camera/Computer Communications.....	86
	SD/MMC Cards and Internal Memory.....	87
	Camera Screen Messages.....	88
	Camera Ready Light Status.....	92
11	Getting Help	95
	Helpful Web Links	95
	Help in this Manual	95
	Software Help.....	95
	Telephone Customer Support	96
12	Appendix	99
	Camera Specifications.....	99
	Shutter Speeds	101
	Original Factory Settings.....	102
	Upgrading Your Software and Firmware	103
	Tips, Safety, Maintenance.....	103
	Storage Capacities.....	104
	Locating Pictures and Videos on a Card.....	105
	Picture Naming Conventions	106
	Power-Saving Features.....	107
	Optional AC Adapter	107
	FCC Compliance and Advisory.....	108

1 Getting Started

Install Software First

Install the software from the Kodak EasyShare software CD **before** connecting the camera (or camera dock) to the computer. Failure to do so may cause the software to load incorrectly.

See the Quick Start Guide or [Installing the Software, page 65](#).

Need This Guide in Larger Print?

For a large print version of this User's Guide:

- 1 Visit www.kodak.com/go/cx6445support.
 - 2 Navigate to the Manuals section.
 - 3 Click *View as PDF* to open the User's Guide.
 - 4 On a Windows OS-based computer or Mac OS 8.6 or 9.x:
 - From the File menu, select Print.
 - In the Print window, select Fit to Page.
- On Mac OS X:
- From the File menu, select Page Setup.
 - Change Scale to 200%.
- 5 Print as usual.

What Can I Do With My Camera?

Capture Still Pictures —Use Auto mode to enjoy point-and-shoot operation. Use Sport, Portrait, Night, Landscape, and Close-up modes to expand your capabilities.

Capture Videos with Sound —Capture videos as QuickTime movies.

Review —Display, protect, and delete pictures and videos; tag for albums.

Share —Share pictures (print, email, save as Favorites) and videos (email, save as Favorites).

Set Up —Customize your camera functions.

What Can I Do With My Pictures and Videos?

Install the software from the Kodak EasyShare software CD, then:

Transfer—Transfer pictures and videos to your computer.

Share—Print pictures, order prints online, email pictures and videos.

Print—(see [page 70](#)) Print pictures directly to your home printer or Kodak EasyShare printer dock 6000. Order prints online from Ofoto, a Kodak Company. Or purchase an optional Kodak multimedia card (MMC) or a secure digital (SD) card and:

- Automatically print to any printer with an SD/MMC slot
 - Make prints at an SD/MMC-capable Kodak picture maker, visit <http://www.kodak.com/go/picturemaker>
 - Take the card to your local photo retailer for professional printing
- Organize**—Use Favorites to organize and retrieve pictures on a computer.

Edit—Add special effects to your pictures, make a custom slide show, fix red-eye, crop, rotate, and much more.

For details, click the Help button in the Kodak EasyShare software. Some Macintosh operating systems may support limited Kodak EasyShare software features.

Package Contents

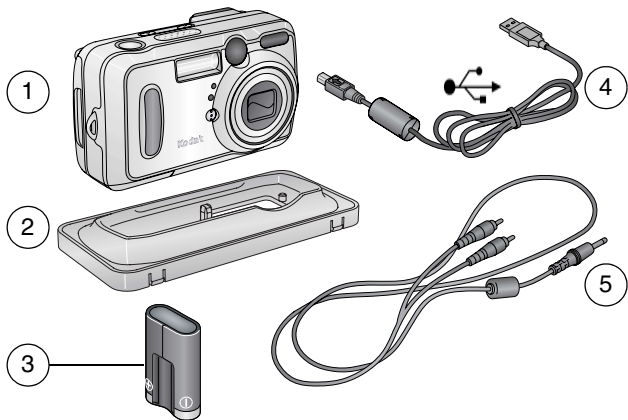

- | | |
|---|---|
| 1 Camera | 4 USB cable |
| 2 Custom insert (for camera dock, see page 72) | 5 Audio/Video cable (for viewing pictures and videos on television) |
| 3 CRV3 battery (non-rechargeable) | |

Not shown: User's Guide, Quick Start Guide, wrist strap, Kodak EasyShare software CD. (In some countries, the User's Guide is provided on a CD.) Contents may change without notice.

Loading the Battery

A CRV3 lithium battery, non-rechargeable, is included with your camera.



- 1 Turn off the camera.
- 2 On the bottom of the camera, slide the battery door and lift to open.
- 3 Insert the CRV3 battery, as shown.
- 4 Close the battery door.

IMPORTANT BATTERY INFORMATION

For acceptable battery life and to make sure your camera operates dependably, do not use alkaline batteries.

See [page 12](#) for the other types of batteries you can use in your camera.

Attaching the Wrist Strap

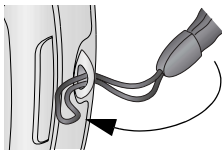

- 1 Thread the short loop of the wrist strap through the wrist strap post.
- 2 Thread the long loop through the short loop.

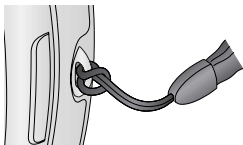

- 3 Pull until secure.

Turning On the Camera

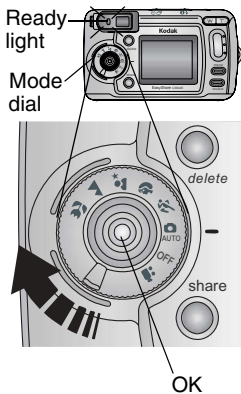

Rotate the Mode dial:

Clockwise for still capture modes

Counterclockwise for video mode

The ready light blinks while the camera performs a self-check, then glows green when the camera is ready to take pictures (or videos, if the mode dial is set to ).

In Still and Video modes, status icons appear on the camera screen. See [Checking Camera Status, page 7](#).

Adjusting the Display

If you want to	Then do this
Turn the camera screen on (enter Liveview) or off.	Press the OK button.
Change the Liveview setting so that it is on whenever the camera is on.	See Turning On Liveview in Still Modes, page 61 .
Redisplay the status icons.	Press  .
Turn off the camera.	Turn the Mode dial to Off. <i>The camera completes operations that are in process.</i>

Setting the Date and Time

Setting the Date & Time, First Time

The *Date & Time have been reset* message appears the first time you turn on the camera or if the battery is removed for an extended time.



OK

- 1 SET DATE & TIME is highlighted. Press the OK button.

(Select Cancel to set the date and time at a later time.)

The Date & Time screen appears.

- 2 Go to step 4 below, [Setting the Date & Time, Anytime.](#)

Setting the Date & Time, Anytime



Joystick/OK

Menu

- 1 Turn on the camera. Press the Menu button.
- 2 Press $\blacktriangle/\blacktriangledown$ to highlight Setup, then press the OK button.
- 3 Press $\blacktriangle/\blacktriangledown$ to highlight Date & Time, then press the OK button.

The date format is YYYY/MM/DD. The time is displayed in a 24-hour format.

- 4 Press $\blacktriangle/\blacktriangledown$ to adjust the date and time. Press $\blacktriangle/\blacktriangledown$ to advance to the next setting.
- 5 When finished, press the OK button.
- 6 Press the Menu button to exit the menu.

The setting remains until you change it.

NOTE: Depending on your computer operating system, Kodak EasyShare software may allow your computer to automatically update the camera clock when you connect the camera. See the Kodak EasyShare software Help for details.

Checking Camera Status

The icons that appear on the camera screen indicate the active camera and picture settings. See [page 8](#) for a list of the icons.

To check the current camera settings:

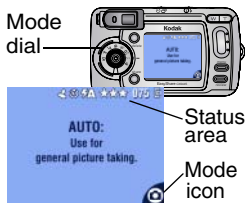

- Turn the Mode dial from the Off position. If **i** is displayed in the status area, press the Flash/Status button to display additional settings. Press **▲** to redisplay the status information at any time.































- Press the Flash button. The current camera status icons are displayed in the bottom half of the Flash screen.



- Press the Shutter button **halfway down** when Liveview is on. Current aperture, shutter speed, and digital zoom values are displayed. Other icons temporarily disappear.

Camera Screen Icons

These icons appear on your camera screen when the settings are active.

Capture Modes (also on Mode dial*)		Camera/Picture Status		
 Video	 Print	Quality Icons		Protect 
 Auto	 Email	★★★ Best ★★★ Best (3:2) ★★ Better ★ Good		
 Sport	 Favorite	 Self Timer	Storage/Picture location	
 Portrait	 Burst	 Internal memory	 Memory Card	
 Night	 Flash**	Battery power		
 Landscape	TRIP+ Album name	 Low  Exhausted		
 Close-up	LT Long time exposure	072 Pictures remaining		
	 Date stamp	 Digital zoom		
 Custom (When  is displayed in the status area, it means there are additional settings. Press the Flash button to display them.)				
 Exposure Compensation	 White balance	 Exposure metering		
 Color mode	ISO ISO speed	 Focus zone	 Album	

*For Capture mode descriptions, see [page 16](#). **For flash icons, see [page 21](#).

Inserting an SD/MMC Card

Your camera has 16 MB of internal memory. However, optional SD/MMC cards provide removable, reusable storage for pictures and videos.



CAUTION:

The card can only be inserted one way; forcing it may damage the camera or card.

Do not insert or remove a card when the green ready light is blinking; doing so may damage your pictures, card, or camera.

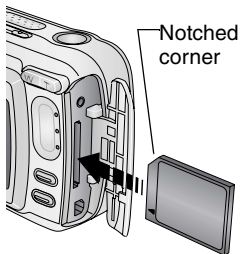

To insert an SD/MMC card:

- 1 Turn off the camera.
- 2 Open the card door.
- 3 Orient the card as shown on the card door.
- 4 Push the card into the slot to seat the connector.
- 5 Close the door.

To remove the card, push it in, then release it. When the card is partially ejected, pull it out.

See [page 104](#) for storage capacities. Purchase SD/MMC cards at a dealer of Kodak products or visit www.kodak.com/go/cx6445accessories.



Choosing Internal Memory or SD/MMC Card

The camera offers two options for storing pictures and videos:



Internal Memory —Store pictures and videos in 16 MB internal memory.

SD/MMC Card —Store pictures and videos on a card. The number/length of pictures/videos depends on the size of the card. Purchase accessories at a dealer of Kodak products or visit www.kodak.com/go/cx6445accessories. For storage capacities, see [page 104](#).

Managing Your Storage Location Setting

- 1 Turn on the camera.
- 2 In any still or video mode, press the Menu button.
- 3 Press / to highlight Image Storage , then press the OK button.



- 4 Press / to highlight an option, then press the OK button:

Auto (default)—the camera uses the card if one is in the camera. If not, the camera uses internal memory.

Internal Memory—the camera always uses internal memory, even if a card is installed.

- 5 Highlight Continue, then press the OK button again.
The setting remains until you change it and applies to all camera functions.
- 6 Press the Menu button to exit the menu.

Checking Your Storage Setting

In **Still and Video modes**, the storage location icon that appears in the status area indicates the camera's storage location. To check the location, either:

Storage location

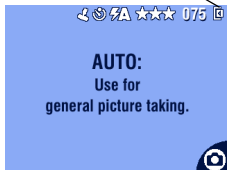

- Turn the Mode dial from the Off position, or
- In any capture mode, press ▲.



—Memory Card



—Internal Memory

Checking a Picture or Video's Location

In **Review mode**, the storage location icon that appears with a picture indicates the location of the picture or video.

Picture/video location

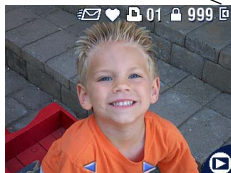

Press the Review button.



—Picture or video is stored on a card



—Picture or video is stored in internal memory

Important Battery Information

Choose the replacement battery that fits your needs—and get the best performance.

Kodak Battery Replacement Types/Battery Life

Your camera can use the following types of batteries. Actual battery life may vary based on usage.

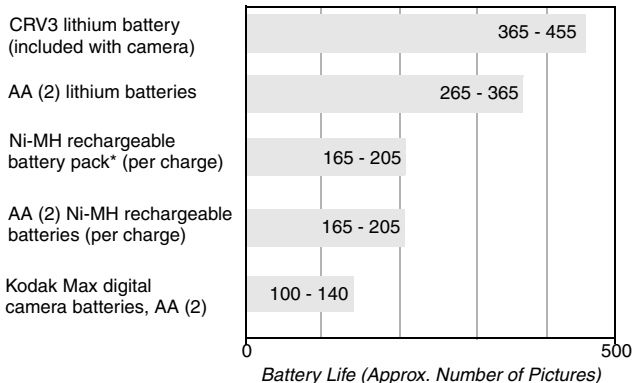

* Included with the Kodak EasyShare camera dock 6000 and printer dock 6000

We do not recommend or support alkaline batteries. For acceptable battery life, and to make sure your camera operates dependably, use the replacement batteries listed above.

For information on batteries, visit

<http://www.kodak.com/global/en/service/batteries/batteryUsage.jhtml>

Extending Battery Life

- Battery life depends significantly on battery age, usage conditions, and type. Digital cameras are demanding on batteries. Not all batteries perform well under these challenging conditions.
- Limit the following activities that quickly deplete battery power:
 - Reviewing your pictures on the camera screen (see [page 45](#))
 - Using Liveview (see [page 17](#))
 - Using Quickview (see [page 19](#) and [page 40](#)).
 - Excessive use of the flash
- Purchase an optional Kodak 3-volt AC adapter to power your camera (see [page 107](#)).
- Purchase an optional Kodak EasyShare camera dock 6000 (see [page 71](#)). The camera dock 6000 powers your camera, transfers pictures, and is also a battery charger for its included Kodak EasyShare Ni-MH rechargeable battery pack.
- Purchase an optional Kodak EasyShare printer dock 6000 (see [page 70](#)). The printer dock 6000 powers your camera, makes 4 x 6 prints with or without a computer, transfers pictures, and is also a battery charger for its included Kodak EasyShare Ni-MH rechargeable battery pack.
- Dirt on the battery contacts can affect battery life. Wipe the contacts with a clean, dry cloth before loading batteries in the camera.
- Battery performance is reduced at temperatures below 41° F (5° C). Carry spare batteries when using your camera in cold weather, and keep them warm. Do not discard cold batteries that do not work; when they return to room temperature, they may be usable.

Battery Safety and Handling

- Do not allow batteries to touch metal objects, including coins. Otherwise, a battery may short circuit, discharge energy, become hot, or leak.
- For rechargeable battery disposal information, visit the Rechargeable Battery Recycling Corporation Web site at www.rbrc.com.

2 Taking Pictures

The camera is ready to take pictures when you turn it on—even if you are in Review, Share, or Setup. (In Video mode, the camera captures video.) Before you take a picture, make sure the storage location is set the way you want it (see [page 10](#)).

Take a Picture

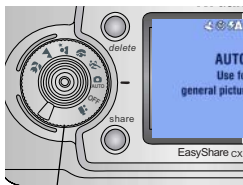

Mode dial

Ready light

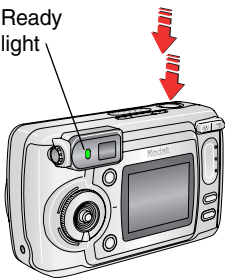

- 1 Turn the Mode dial to the mode you want to use. See [page 16](#) for a description of the picture-taking modes.

The camera screen displays the mode name and description. To interrupt the description, press any button.

- 2 Use the viewfinder or camera screen to frame your subject. (Press the OK button to turn Liveview on. See [page 17](#).)
- 3 Press the Shutter button **half-way** to set the exposure and focus.
- 4 When the ready light glows green, continue pressing the Shutter button **completely down** to take the picture.

When the ready light blinks green, the picture is being saved; you can still take pictures. If the ready light is red, wait until it turns green.





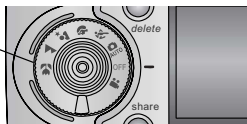

See [Flash Settings In Each Mode](#), [page 22](#).

See [Changing Optional Settings](#), [page 25](#).

Picture-Taking Modes

For the best possible pictures, choose the mode that suits your conditions.



Use this mode	For:
 Auto	General picture-taking. Automatically sets exposure, focus, and flash.
 Sport	Subjects that are in motion. Shutter speed is fast.
 Portrait	Full-frame portraits of people. Allows the subject to be sharp and the background to be indistinct. For best results, fill the frame with a head-and-shoulders pose. Use the Telephoto (T) zoom button to exaggerate background blur.
 Night	Night scenes or low-light conditions. For shutter speeds slower than 1/60 second, place the camera on a flat, steady surface or use a tripod. Due to slow shutter speeds, advise people to stay still for a few seconds after the flash fires.
 Landscape	Distant subjects. Flash does not fire unless you turn it on. Auto focus framing marks (see page 18) are not available in Landscape.
 Close-up	Close subjects 4-24 in. (10-60 cm) from the lens in Wide Angle; 9.8-33.5 in. (25-85 cm) in Telephoto. Use available light instead of flash if possible. Use the camera screen to frame the subject.
 Video	Capture video with sound. See Taking Videos, page 39 .

Liveview—Framing with the Camera Screen

When you turn on Liveview, the camera screen displays a live image of what the lens sees. Use the camera screen to frame your subject.

IMPORTANT: *Liveview quickly depletes battery power; use it sparingly.*

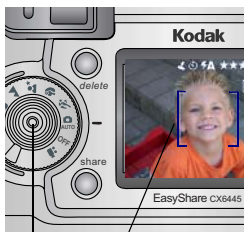

OK

Framing marks

- 1 Turn the Mode dial to any On position.
- 2 Press the OK button to turn on Liveview.
- 3 Frame your subject in the camera screen.
To use the auto focus framing marks, see [page 18](#).
- 4 Press the Shutter button **half-way and bold** to set the exposure and focus, then press **the rest of the way down** to take the picture.
- 5 To turn off Liveview, press the OK button.



NOTE: If Quality is set to Best (3:2), the Liveview image is displayed at a 3:2 aspect ratio, as shown, with a black bar at the top of the screen.

To change the Liveview setting so that it is on whenever the camera is on, see [page 61](#).





Using the Auto Focus Framing Marks

In Liveview, the framing marks indicate the area of your scene that the camera is focusing on. For the best possible pictures, the camera attempts to focus on foreground subjects, even if the subjects are not centered in the scene.

- 1 Press the OK button to turn on Liveview.
- 2 Press the Shutter button **half-way and bold**.

The framing marks are displayed. When they turn red, focus is accomplished.

While the Shutter Button is Pressed Half-way:

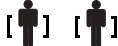
 <p>Framing marks</p>		Center focus
		Center wide focus
		Side focus
		Center and side focus
		Left and right focus

- 3 Press the Shutter button **the rest of the way down** to take the picture.
- 4 If the camera is not focusing on the desired subject (or if the framing marks disappear), release your finger, recompose the scene, and repeat Steps 2 and 3.

NOTE: Framing marks appear only when Liveview is on.

Framing marks do not appear in Landscape mode.

When you use the Focus Zone feature ([page 34](#)) and set Center Zone, the framing marks are fixed at Center wide.

Quickview—Reviewing the Picture Just Taken

After you take a picture, the camera screen displays a Quickview of that picture for approximately 5 seconds. While the picture is displayed, you can:



- **Review it:** If you take no action, the picture is saved.
- **Share it:** Press the Share button to tag the picture for print, email, or as a Favorite (see [page 55](#)).
- **Delete it:** Press the Delete button while the picture and  are displayed. Follow the prompts to delete the picture.

NOTE: Only the final of a burst series of pictures (see [page 24](#)) is displayed during Quickview. If you select Delete, all pictures in the burst series are deleted. To delete selectively, do so in Review (see [page 47](#)).

To save battery power, you can turn off the Quickview feature (see [page 60](#)).

Adjusting the Viewfinder

Use the diopter dial to adjust the viewfinder for your eyesight. Adjusting the diopter has no effect on the camera auto focus.

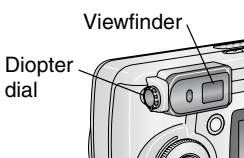

- 1 In a well-lit area, turn on the camera.
- 2 Look through the viewfinder and turn the diopter dial until the scene you are framing is clear and focused.

Using the Optical Zoom

Use Optical Zoom to get up to 4X closer to your subject. Optical zoom is effective when the lens is no closer than 19.7 in. (50 cm) to the subject. When you turn on the camera, the lens extends to the Wide Angle position.

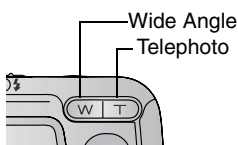

- 1 Use the viewfinder or camera screen to frame your subject.
- 2 Press Telephoto (T) to zoom in. Press Wide Angle (W) to zoom out.

The lens extends or retracts. The viewfinder or camera screen displays the zoomed image.

- 3 Press the Shutter button **half-way and hold** to set the exposure and focus, then press **the rest of the way down** to take the picture.

NOTE: The lens retracts when you turn off the camera.

Using the Advanced Digital Zoom

Use Advanced Digital Zoom to get an additional 3.8X magnification beyond Optical Zoom; available settings are from 4.0X to 15X in 0.8 increments. You must turn Liveview on to activate Advanced Digital Zoom.

IMPORTANT: *You may notice a decrease in printed image quality when using Digital Zoom.*

- 1 Press the OK button to turn on Liveview.
- 2 Press the Telephoto (T) button to the Optical Zoom limit. Release the button, then press it again.

The camera screen displays the zoomed image and the magnification

 6.4X.

- 3 Press the Shutter button **half-way and hold** to set the exposure and focus, then press **the rest of the way down** to take the picture.

NOTE: You can change the way the digital zoom is turned on. See [page 62](#).

Using the Flash

Use the flash when you take pictures at night, indoors, or outdoors in heavy shadows. Flash is effective between 1.6-16.7 ft (0.5-5.1 m) in Wide angle and between 2.5-8.5 ft (0.75-2.6 m) in Telephoto.

The flash setting can be changed in any Still mode. The default flash setting is restored when you exit the mode or turn off the camera (see [page 22](#)).

Turning On the Flash



Press the  button repeatedly to scroll through the flash options.

The active flash icon is displayed in the camera screen status area ([page 8](#)).



Auto* (default)—flash fires when the lighting conditions require it.



Off—flash never fires.



Fill—flash fires every time you take a picture, regardless of the lighting conditions.











Red-eye*—flash fires once so the subject's eyes become accustomed to the flash, then fires again when the picture is taken. (If the lighting conditions require flash but do not require Red-eye reduction, the flash may fire only once.)

* The flash may fire, even in bright outdoor conditions, if the background is brighter than your subject.

Flash Settings In Each Mode

For the best possible pictures, flash settings are pre-set for each picture taking mode.

Icon	Capture Mode	Default Flash Setting	Available Flash Settings (press the Flash button to change)	To Return to the Default Flash Setting:
	Auto	Auto*	Auto, Flash Off, Fill Flash, Red-eye	Exit the mode or turn off the camera.
	Sport	Auto		
	Portrait	Auto*		
	Night	Auto*		
	Landscape	Off		
LT	Long Time Exposure	Off		
	Close-up	Off		
	Video	Off	None	Flash cannot be turned on.
	Burst	Off		

* In these modes, when you change to Red-eye, it remains until you change it.

Putting Yourself in the Picture

The Self Timer creates a 10-second delay between the time you press the Shutter button and the time the picture is taken.

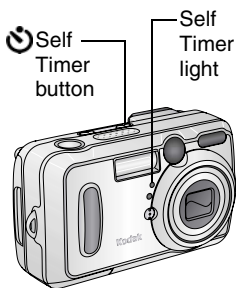

- 1 Place the camera on a flat surface or use a tripod.
- 2 In any Still mode, press the Self Timer button.

The Self Timer icon  appears in the status area.

- 3 Compose the scene. Then press the Shutter button **half-way and hold** to set the exposure and focus, then press **the rest of the way down**. Move so that you are in the scene.

The Self Timer light blinks slowly for 8 seconds (then quickly for 2 seconds) before the picture is taken. The camera "clicks" when the picture is captured. To turn off the shutter sound, see [page 62](#).

The Self Timer turns off after you take the picture or if you change modes.

To cancel the Self Timer before the picture is taken, press the Self Timer button. (The Self Timer setting remains active.)

To turn off the Self Timer, press the Self Timer button twice.

Taking a Burst Series of Pictures

Burst lets you to take up to 6 pictures in quick succession (approximately 3 frames per second). Burst is ideal for capturing sporting events or objects in motion. Flash and Self Timer are disabled when you use Burst.

Turn On Burst



In any Still mode, press the Self Timer/Burst button **twice**.

The Burst icon  appears in the status area.

NOTE: The setting remains until you change it or turn off the camera.

Take the Pictures

- 1 Press the Shutter button **half-way and hold** to set the auto-focus and exposure for all the pictures in the sequence.
- 2 Press the Shutter button **the rest of the way down and hold it** to take the pictures.





The camera takes up to 6 pictures in quick succession. It stops taking pictures when the Shutter button is released, when 6 pictures are taken, or when there is no more storage space.













Exposure, focus, white balance, and orientation are set for the first picture and applied to all 6 pictures.

Changing Optional Settings

Press the Menu button to access optional picture-taking settings. All menu options are not available in all modes.



Menu Options Available	Picture Taking Modes			
	Video	Auto Sport Portrait Night	Landscape	Close-up
 Image Storage (page 10)	●	●	●	●
 Exposure Comp. (page 27)		●	●	●
 Picture Quality (page 28)		●	●	●
 Color Mode (page 29)		●	●	●
 White Balance (page 30)			●	●

Menu Options Available	Picture Taking Modes			
	Video 	Auto  Sport  Portrait  Night 	Landscape 	Close-up 
ISO ISO Speed (page 31)			●	●
LT Long Time Exp. (page 32)			●	
 Exp. Metering (page 33)			●	●
[] Focus Zone (page 34)				●
 Set Album (page 35)	●	●	●	●
 Date Stamp (page 36)		●	●	●
 Orientation Sensor (page 37)		●	●	●
 Setup (page 59)	●	●	●	●

Setting Exposure Compensation

Use Exposure Compensation to control how much light enters the camera. This setting is useful for taking pictures in high-contrast scenes, or for retaking pictures when you are not satisfied with the brightness.

Adjust the exposure by plus or minus 2 steps in 1/2-step increments.

NOTE: Exposure Compensation cannot be used with Long Time Exposure.

- 1 In any Still mode, press the Menu button.
- 2 Press $\blacktriangle/\blacktriangledown$ to highlight Exposure Compensation , then press the OK button.

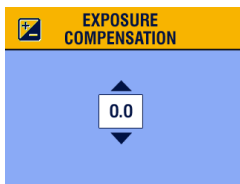

- 3 Press $\blacktriangle/\blacktriangledown$ to select the Exposure Compensation setting.
 - If pictures are too light, decrease the value.
 - If pictures are too dark, increase the value.
- 4 Press the OK button to accept the change.
- 5 Press the Menu button to exit the menu.
- 6 Use the camera screen to frame your subject. Press the Shutter button *half-way and bold* to set the focus, then *press the rest of the way down* to take the picture.

This setting remains until you change the Mode dial or turn off the camera.

Setting Picture Quality

Use the Quality setting to select a picture resolution.

1 In any Still mode, press the Menu button.



2 Press $\blacktriangle/\blacktriangledown$ to highlight Quality \star , then press the OK button.

3 Highlight an option:

Best $\star\star\star$ (4.0 MP)—for printing up to 20 x 30 in. (51 x 76 cm); pictures are highest resolution and largest file size.

$\star\star\star$ *appears in the status area.*

Best (3:2) $\star\star\star$ (3.5 MP)—for printing up to 11 x 14 in. (28 x 36 cm); also ideal for printing to the Kodak EasyShare printer dock 6000 and other printing solutions (see [page 70](#)).

$\star\star\star$ *appears in the status area.*

Better $\star\star$ (2.1 MP)—for printing up to 8 x 10 in. (20 x 25 cm); pictures are medium resolution with smaller file size.

$\star\star$ *appears in the status area.*

Good \star (1.1 MP)—for emailing, Internet, or screen display; pictures are lowest resolution and smallest file size.

\star *appears in the status area.*

4 Press the OK button.

5 Press the Menu button to exit the menu.

This setting remains until you change it.

Setting Color Mode

Use Color Mode to control color tones and moods.

- 1 In any Still mode, press the Menu button.
- 2 Press $\blacktriangle/\blacktriangledown$ to highlight Color Mode **BW**, then press the OK button.



- 3 Press $\blacktriangle/\blacktriangledown$ to highlight an option, then press the OK button.

Color (default)—for color pictures.

Black & White—for black and white pictures.

Sepia—for pictures with a reddish-brown, antique look.

- 4 Press the Menu button to exit the menu.

This setting remains until you change the Mode dial or turn off the camera.

Setting White Balance

Whites can look white in daylight, but different under other lighting conditions. Use White Balance to correct the color shifts that result from shooting pictures under different light sources.

NOTE: White Balance is available in Landscape and Close-up modes.

- 1 In any Still mode, press the Menu button.
- 2 Press $\blacktriangle/\blacktriangledown$ to highlight White Balance , then press the OK button.

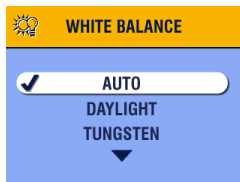

- 3 Press $\blacktriangle/\blacktriangledown$ to highlight an option, then press the OK button.

Auto (default)— automatically corrects white balance. Ideal for general picture taking.

Daylight—for pictures in natural lighting.

Tungsten—corrects the orange cast of household incandescent (tungsten) or halogen light bulbs. Ideal for indoor pictures without flash.

Fluorescent—corrects the green cast of fluorescent lighting. Ideal for indoor pictures under fluorescent lighting without flash.

- 4 Press the Menu button to exit the menu.

This setting remains until you change the Mode dial or turn off the camera.

Setting ISO Speed

The ISO setting controls the camera's sensitivity to light. Use a lower ISO setting in brightly lit scenes; use a higher ISO setting for low-light scenes.

NOTE: ISO settings are available in Landscape and Close-up modes. Higher ISO speeds may create a picture that is “noisier” than a picture taken at lower ISO speeds.

- 1 In any Still mode, press the Menu button.
- 2 Press $\blacktriangle/\blacktriangledown$ to highlight ISO Speed **ISO**, then press the OK button.
- 3 Press $\blacktriangle/\blacktriangledown$ to highlight an option, then press the OK button.

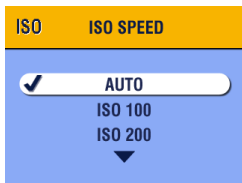

AUTO (default)—sets an ISO speed (100-200) based on scene brightness. Ideal for general picture taking.

ISO 100—for daylight pictures in bright sun, when fine detail is needed. Ideal for portraits or nature scenes.

ISO 200—for cloudy, overcast days. Ideal when you need extra speed without sacrificing image quality.

ISO 400—for dusk or night pictures when flash is prohibited. Ideal for sporting events and excellent for indoor shots with or without flash.

- 4 Press the Menu button to exit the menu.

This setting remains until you change the Mode dial or turn off the camera.

Setting Long Time Exposure





In Landscape mode, use Long Time Exposure to control how long the shutter stays open and to portray a sense of motion. Settings range from 0.7 to 4 seconds.

NOTE: Long Time Exposure cannot be used with Exposure Compensation or manual ISO speed setting.

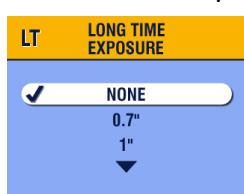
When using Long Time Exposure, ISO speed is set to Auto with an automatic value of 100.

Set Long Time Exposure



- 1 Turn the Mode dial to Landscape .
- 2 Press the Menu button.
- 3 Press / to highlight Long Time Exposure **LT**, then press the OK button.
- 4 In any Still mode, press the Menu button.
- 5 Press / to select an option, then press the OK button.
- 6 Press the Menu button to exit the menu.

Take the Picture

- 1 Place the camera on a flat surface or use a tripod.
- 2 Use the camera screen to frame your subject. Press the Shutter button **half-way and hold** to set the focus. Press **the rest of the way down** to take the picture.

This setting remains until you change the Mode dial or turn off the camera.

Setting Exposure Metering

Your camera uses matrix metering to set exposure values; it evaluates light levels in multiple locations within the scene to provide the best exposure for the main subject.

Use Exposure Metering to target specific areas of a scene for evaluation.

NOTE: Exposure Metering is available in Landscape and Close-up modes.

- 1 In any Still mode, press the Menu button.
- 2 Press $\blacktriangle/\blacktriangledown$ to highlight Exposure Metering , then press the OK button.

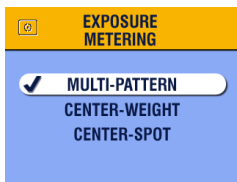

- 3 Press $\blacktriangle/\blacktriangledown$ to highlight an option, then press the OK button.

Multi-pattern (default)—evaluates lighting conditions throughout the image to give an optimum picture exposure. Ideal for general picture taking.

Center-weight—evaluates the lighting conditions of the subject centered in the viewfinder. Ideal for backlit subjects.

Center-spot—similar to Center-weighted, except the metering is concentrated on a smaller area of the subject centered in the viewfinder. Ideal when you need an exact exposure of a specific area in the picture.

- 4 Press the Menu button to exit the menu.

This setting remains until you change the Mode dial or turn off the camera.

Setting Focus Zone

If you do not get the composition and focus results you want by using framing marks (page 18), use the Focus Zone feature to select a large or a concentrated area of focus.

NOTE: Focus Zone is available in Close-up mode.

- 1 In any Still mode, press the Menu button.
- 2 Press $\blacktriangle/\blacktriangledown$ to highlight Focus Zone [], then press the OK button.

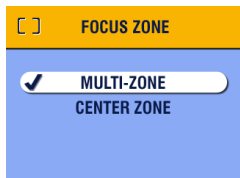

- 3 Press $\blacktriangle/\blacktriangledown$ to highlight an option, then press the OK button.

Multi-zone (default)— evaluates 3 zones to give an even picture focus. Ideal for general picture taking.

Center zone—evaluates the small area centered in the viewfinder. Ideal when precise focus of a specific area in the picture is needed.

- 4 Press the Menu button to exit the menu.

This setting remains until you change the Mode dial or turn off the camera.

Pre-tagging for Album Names



Use the Set Album (Still) feature to pre-select album names before you take pictures. Then, all the pictures you take are tagged with those album names.

First—On Your Computer

Use Kodak EasyShare software, V 3.0 or higher, to create album names on your computer, then copy up to 32 album names to the camera's internal memory. See Kodak EasyShare software Help for details.

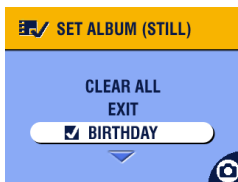
Second—On Your Camera



- 1 In any Still mode, press the Menu button.
- 2 Highlight Set Album , then press the OK button.
- 3 Press / to highlight an album name, then press the OK button. Repeat to add pictures to more than one album.
Selected albums are noted with a check mark.
- 4 To remove a selection, highlight an album name and press the OK button. To remove all album selections, select Clear All.



- 5 Highlight Exit, then press the OK button.

Your selections are saved. If you turn on Liveview, your album selection is displayed on the screen. A plus (+) after the album name means more than one album is selected.

- 6 Press the Menu button to exit the menu.

This setting remains until you change it.

Third—Transfer to Your Computer

When you transfer the tagged pictures to your computer, the Kodak EasyShare software opens and categorizes your pictures in the appropriate album folder. See the Kodak EasyShare software Help for details.

Placing the Date on Pictures

Use the Date Stamp setting to imprint the date on your pictures.

- 1 Make sure the camera clock is set to the correct date ([page 6](#)).
- 2 In any Still mode, press the Menu button.
- 3 Press $\blacktriangle/\blacktriangledown$ to highlight Date Stamp , then press the OK button.

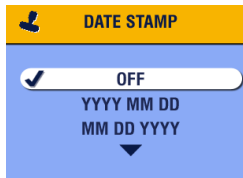

- 4 Press $\blacktriangle/\blacktriangledown$ to highlight an option, then press the OK button.
- 5 Press the Menu button to exit the menu.

The current date is printed in the bottom right corner of new pictures. This setting remains until you change it.

Setting the Orientation Sensor

If you rotate the camera to take a picture (for example, a portrait shot), the Orientation Sensor reorients the picture so that it is displayed correct side up. The Orientation Sensor is turned on as the default. You can turn it off so that pictures are displayed in their original orientation.

NOTE: When your subject is above or below you (such as pictures of an object in the sky, on the ground, or when pointing down at small objects on a table), **turn off the Orientation Sensor** so that pictures are not rotated unnecessarily.

- 1 In any Still mode, press the Menu button.
- 2 Press $\blacktriangle/\blacktriangledown$ to highlight Orientation Sensor , then press the OK button.

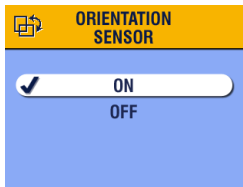

- 3 Press $\blacktriangle/\blacktriangledown$ to highlight On or Off, then press the OK button.
- 4 Press the Menu button to exit the menu.

This setting remains until you change it.

3 Taking Videos

Use Video mode  to take videos or to customize video-taking settings. Before you take a video, make sure your picture storage location is set the way you want it (see [page 10](#)).

NOTE: Flash is not available in Video mode.

You can set Optical Zoom before, but not during, video recording.

Taking a Video



- 1 Turn the Mode dial to Video .
A live image, camera status, and the recording time available appear on the camera screen.
- 2 Use the viewfinder or camera screen to frame your subject.
- 3 To begin recording, press the Shutter button completely down and release within 2 seconds.

Self Timer/
Video light



The Ready light blinks green, REC appears on the camera screen, and the Self Timer/Video light stays on while recording.

- 4 To stop recording, press the Shutter button again.

Recording also stops if the storage location is full. See [page 104](#) for video storage capacities.

NOTE: If you prefer, press the Shutter button completely down **and hold it** for more than 2 seconds to begin recording. To stop recording, release the Shutter button.

Quickview—Reviewing the Video Just Taken

After you take a video, the camera screen displays the first frame of the video for approximately 5 seconds. While the frame is displayed, you can:



- **Play it:** Press the OK button. Press ▲/▼ to adjust the volume. Press OK again to pause the video.
- **Share it:** Press the Share button to tag the video for email or as a Favorite (see [page 55](#)).
- **Delete it:** Press the Delete button while the video and  are displayed.

You can turn off the Quickview feature (see [page 60](#)). When Quickview is turned off, the video is not displayed on the camera screen after you take it.

Using the Optical Zoom

Use Optical Zoom to get up to 4X closer to your subject. When you turn on the camera, the lens is set to the Wide Angle position.

NOTE: You can change Optical Zoom before (but not during) video recording.

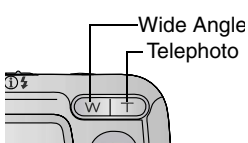

- 1 Use the viewfinder or camera screen to frame your subject.
- 2 Press Telephoto (T) to zoom in. Press Wide Angle (W) to zoom out.

The lens extends or retracts. The viewfinder or camera screen displays the zoomed image.

- 3 Press the Shutter button to take the video.

Changing Optional Video Settings

In Video mode, press the Menu button to access optional video-taking settings.

	Image Storage (page 10)
	Album (page 42)
	Setup Menu (page 59)

Pre-tagging for Album Names



Use the Set Album (Video) feature to pre-select album names before you take videos. Then, all the videos you take are tagged with those album names.

First—On Your Computer

Use Kodak EasyShare software, V 3.0 or higher, to create album names on your computer, then copy up to 32 album names to the camera's internal memory. See Kodak EasyShare software Help for details.

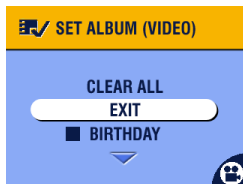
Second—On Your Camera



- 1 In Video mode, press the Menu button.
- 2 Highlight Set Album , then press the OK button.
- 3 Press / to highlight an album name, then press the OK button. Repeat to add videos to more than one album.

Selected albums are noted with a check mark.

- 4 To remove a selection, highlight an album name and press the OK button. To remove all album selections, select Clear All.
- 5 Highlight Exit, then press the OK button.

Your selections are saved. If you turn on Liveview, your album selection is displayed on the screen. A plus (+) after the album name means more than one album is selected.

- 6 Press the Menu button to exit the menu.
This setting remains until you change it.

Third—Transfer to Your Computer

When you transfer the tagged videos to your computer, the Kodak EasyShare software opens and categorizes your videos in the appropriate album folder. See the Kodak EasyShare software Help for details.

Putting Yourself in the Video

The Self Timer creates a 10-second delay between the time you press the Shutter button and the time video recording begins.



- 1 Place the camera on a flat surface or use a tripod.
- 2 Turn the Mode dial to Video , then press the Self Timer button.
- 3 Press $\blacktriangle/\blacktriangledown$ to highlight a Video Length option, then press the OK button:

Unlimited—records until you stop recording or until storage is full.

Seconds—records for the specified time or until storage is full.

NOTE: If the current storage location does not have adequate space, some video length options are not displayed. (See [page 104](#) for video storage capacities.)

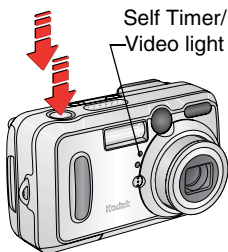

- 4 Compose the scene, then press the Shutter button completely down. Move so that you are in the scene.

The Self Timer/Video light blinks slowly for 8 seconds, then quickly for 2 seconds before the video begins recording. It then stays on while recording.

To cancel the Self Timer before the video is taken, press the Self Timer button. (The Self Timer setting remains active.)

To turn off the Self Timer, press the Self Timer button twice.

4 Reviewing Pictures and Videos

Press the Review button to view and work with your pictures and videos. To save battery power, place your camera in the optional Kodak EasyShare camera dock 6000 to review pictures and videos (see [page 78](#)).

Remember, press the Shutter button to take a picture anytime—even in Review.

Viewing Single Pictures and Videos





- 1 Press the Review button.

The camera screen displays the last picture or video taken.

The icons displayed with each picture indicate the applied features. See [Camera Screen Icons, page 8](#).



- 2 Press  to scroll backward or forward through pictures and videos. For fast scrolling, press and hold .
- 3 Press the Review button to exit Review.



NOTE: Pictures taken at the Best (3:2) quality setting are displayed at a 3:2 aspect ratio, as shown, with a black bar at the top of the screen.

Viewing Multiple Pictures and Videos



1 Press the Review button.

2 Press \blacktriangledown .

NOTE: You can also press the Menu button, highlight $\begin{matrix} \square & \square & \square \\ \square & \square & \square \\ \square & \square & \square \end{matrix}$, then press the OK button.

Thumbnails of nine pictures and videos are displayed at once.

3 Press $\blacktriangle/\blacktriangledown$ to display the previous or next row of thumbnails.

4 Press $\blacktriangleleft/\blacktriangleright$ to scroll through the thumbnails one at a time.

The selected picture is highlighted in yellow.

5 Press the OK button to display a single view of the selected picture.

Playing a Video

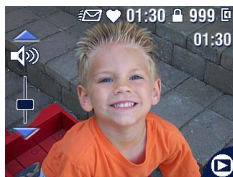

1 Press the Review button.

2 Press $\blacktriangleleft/\blacktriangleright$ to locate a video (or highlight one in multiple view).

3 To play or pause a video, press the OK button.

NOTE: You can also press the Menu button, highlight $\begin{matrix} \square & \square \\ \square & \square \end{matrix}$, then press the OK button.

4 To adjust the volume, press $\blacktriangle/\blacktriangledown$ during playback.

5 To rewind a video, press \blacktriangleleft during playback. To replay the video, press the OK button.

6 To go to the previous or next picture or video, press $\blacktriangleleft/\blacktriangleright$.

Deleting Pictures and Videos

- 1 Press the Review button.
- 2 Press ◀/▶ to locate a picture or video (or highlight one in multiple view), then press the Delete button.

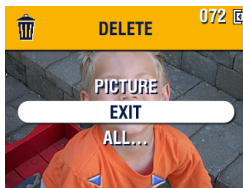













- 3 Press ▲/▼ to highlight an option, then press the OK button:
 - PICTURE or VIDEO**—deletes the displayed picture or video.
 - EXIT**—exits the Delete screen.
 - ALL**—deletes all pictures and videos from your current storage location.
- 4 To delete other pictures and videos, press ◀/▶ .
- 5 To exit delete, highlight EXIT then press the OK button; or just press the Delete button again.

NOTE: You cannot delete protected pictures and videos in this manner. Remove protection before deleting ([page 49](#)).

Changing Optional Review Settings

In Review mode, press the Menu button to access optional review settings.

 	Magnify (pictures) (page 48) Play (videos) (page 46)		Copy (page 53)
	Share (page 55)		Video Date Display (page 54)
	Image Storage (page 10)		Multi-up (page 46)
	Protect (page 49)		Picture/Video Information (page 54)
	Album (page 50)		Setup Menu (page 59)
	Slide Show (page 51)		

Magnifying Pictures

1 Press the Review button, then locate a picture.







OK



2 To magnify at 2X, press the OK button. To magnify at 4X, press the OK button again.

NOTE: You can also press the Menu button, highlight , then press the OK button.

The picture is magnified and the magnification value is displayed. The captured picture is not changed.

3 Press     to see different parts of the picture.

4 Press the OK button to redisplay the picture at the 1X (original) size.

5 Press   to locate a different picture, or press the Review button to exit Review mode.

Protecting Pictures and Videos From Deletion

- 1 Press the Review button, then locate the picture or video to protect.
- 2 Press the Menu button.

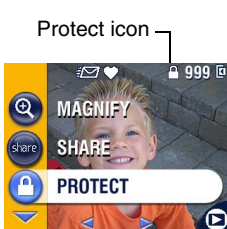

- 3 Press $\blacktriangle/\blacktriangledown$ to highlight Protect , then press the OK button.

The picture or video is protected and cannot be deleted. The Protect icon  appears with the protected picture or video.

- 4 To remove protection, press the OK button again.
- 5 Press the Menu button to exit the menu.



CAUTION:

Formatting internal memory or SD/MMC card deletes protected pictures and videos.

Tagging Pictures/Videos for Albums



Use the Album feature in Review mode to tag the pictures and videos in your camera with album names.

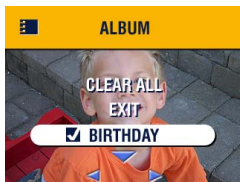

First—On Your Computer

Use Kodak EasyShare software, V 3.0 or higher, to create album names on your computer, then copy up to 32 album names to the camera's internal memory. See Kodak EasyShare software Help for details.

Second—On Your Camera



- 1 Press the Review button.
- 2 Locate a picture, then press the Menu button.
- 3 Highlight Album , then press OK.
- 4 Press / to highlight an album folder, then press OK.

To add other pictures to the same album, press / to scroll through the pictures. When the picture you want is displayed, press OK.

To add the pictures to more than one album, repeat step 4 for each album.

The album name appears with the picture. A plus (+) after the album name means the picture was added to more than one album.

- 5 To remove a selection, highlight an album name and press the OK button. To remove all album selections, select Clear All.
- 6 Highlight Exit, then press the OK button.
Your selections are saved.
- 7 Press the Menu button to return to Review mode.

Third—Transfer to Your Computer

When you transfer the tagged pictures and videos to your computer, the Kodak

EasyShare software opens and categorizes your pictures and videos in the appropriate album folder. See Kodak EasyShare software Help for details.

Running a Slide Show

Use the Slide Show to display your pictures and videos on the camera screen. To run a slide show on a television or on any external device, see [page 52](#). To save battery power, use an optional Kodak AC adapter, 3-volt (see [page 107](#)).

Starting the Slide Show

- 1 Press the Review button, then press the Menu button.
- 2 Press $\blacktriangle/\blacktriangledown$ to highlight Slide Show , then press the OK button.
- 3 Press $\blacktriangle/\blacktriangledown$ to highlight Begin Show, then press the OK button.

Each picture and video is displayed once, in the order in which you took them. Then the camera returns to the Menu screen.
- 4 To cancel the Slide Show, press the OK button.



Changing the Slide Show Display Interval

The default interval setting displays each picture for 5 seconds. You can increase the display interval to up to 60 seconds.

- 1 On the Slide Show menu, press $\blacktriangle/\blacktriangledown$ to highlight Interval, then press the OK button.
- 2 Select a display interval.

To scroll through the seconds quickly, press and hold $\blacktriangle/\blacktriangledown$.
- 3 Press the OK button.

The interval setting remains until you change it.

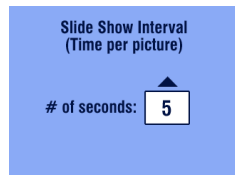

Running a Continuous Slide Show Loop

When you turn on Loop, the slide show is continuously repeated.

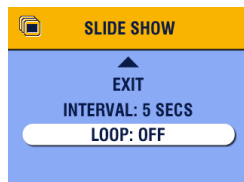

- 1 On the Slide Show menu, press $\blacktriangle/\blacktriangledown$ to highlight Loop, then press the OK button.
- 2 Press $\blacktriangle/\blacktriangledown$ to highlight On, then press the OK button.

When you start a slide show, it repeats until you cancel it by pressing the OK button or until battery power is exhausted. The Loop setting remains until you change it.

Displaying Pictures/Videos on a Television

You can display pictures and videos on a television, computer monitor, or any device equipped with a video input. (Image quality on a television screen may not be as good as on a computer monitor or when printed.)

NOTE: Make sure the Video Out setting (NTSC or PAL) is correct ([page 63](#)).

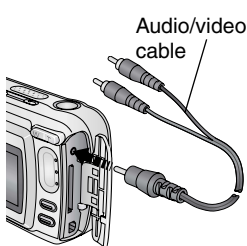

- 1 Connect the audio/video cable (included) from the camera video-out port to the television video-in port (yellow) and audio-in port (white). Refer to your television user's guide for details.
The camera screen turns off; the television screen acts as the camera display.
- 2 Review pictures and videos on the television screen.

NOTE: The slide show stops if you connect or disconnect the cable while the slide show is running.

Copying Pictures and Videos

You can copy pictures and videos from a card to internal memory or from internal memory to a card.

Before you copy, make sure that:

- A card is inserted in the camera.
- The camera's picture storage location is set to the location **from** which you are copying. See [Choosing Internal Memory or SD/MMC Card](#), page 10.

Copy pictures or videos:

- 1 Press the Review button, then press the Menu button.
- 2 Press $\blacktriangle/\blacktriangledown$ to highlight Copy \blacktriangleright , then press the OK button.

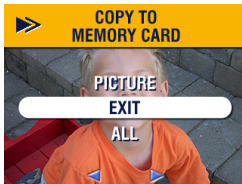

- 3 Press $\blacktriangle/\blacktriangledown$ to highlight an option:
 - PICTURE or VIDEO**—copies the current picture or video.
 - EXIT**—returns to the Review menu.
 - ALL**—copies all pictures and videos from your selected storage location to the other location.

- 4 Press the OK button.

A progress bar monitors the copy process until complete. (For information on picture numbering, see [page 105](#).)

NOTE:

- Pictures and videos are copied, not moved. To remove pictures and videos from the original location after they are copied, delete them (see [page 47](#)).
- Tags that you applied for print, email, and Favorites are not copied. Protection settings are not copied. To apply protection to a picture or video, see [page 49](#).

Displaying Video Date

To display the capture date and time (only during video playback on the camera):

- 1 Press the Review button, then press the Menu button.
- 2 Press $\blacktriangle/\blacktriangledown$ to highlight Video Date Display , then press the OK button.

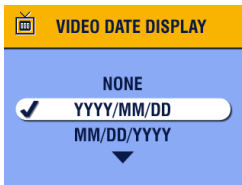

- 3 Press $\blacktriangle/\blacktriangledown$ to highlight an option, then press the OK button.
- 4 Press the Menu button to exit the menu.

The capture date and time appear during video playback on the camera. This setting remains until you change it.

Viewing Picture/Video Information

- 1 Press the Review button, then press the Menu button.



- 2 Press $\blacktriangle/\blacktriangledown$ to highlight Picture or Video Info, then press the OK button.

Information about the picture or video is displayed.

- 3 To view information on the next or previous picture or video, press $\blacktriangle/\blacktriangleright$. Press the Menu button to exit the menu.

5 Sharing Pictures and Videos

The Share button lets you “tag” your pictures and videos. When they are transferred to your computer, you can share:

Tagged Pictures

- By print
- By email
- As Favorites, for easy organization on your computer

Tagged Videos

- By email
- As Favorites

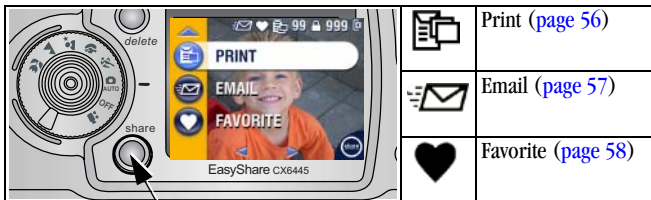

When Can I Tag My Pictures and Videos?

Press the Share button to tag pictures and videos:

- Any time (the last picture taken and the Share menu are displayed).
- Just after you take them, during Quickview (see [page 19](#) and [page 40](#)).
- After pressing the Review button (see [page 45](#)).

NOTE: Tags remain until removed. If a tagged picture or video is copied, the tag is **not** copied. In a burst series, only the last picture is tagged during Quickview.

Tagging Pictures for Printing



- 1 Press the Share button. Press \leftarrow/\rightarrow to locate a picture.
- 2 Highlight Print , then press the OK button.*
- 3 Press \uparrow/\downarrow to select the number of copies (0-99). Zero removes the tag for that picture.

The Print icon  appears in the status area. The default quantity is one. (To change the default, see [page 60](#).)

- 4 **Optional:** You can apply a print quantity to other pictures. Press \leftarrow/\rightarrow to locate a picture. Keep the print quantity as is, or press \uparrow/\downarrow to change it. Repeat this step until the desired print quantity is applied to the pictures.
- 5 Press the OK button. Then press the Share button to exit the menu.

* To tag all pictures in the storage location, highlight Print All , press the OK button, then indicate the number of copies as described above. Print All is not available in Quickview.

To remove the print tagging for all pictures in the storage location, highlight Cancel Prints, then press the OK button. Cancel Prints is not available in Quickview.

Printing Tagged Pictures

When you transfer the tagged pictures to your computer, the Kodak EasyShare software print screen opens. For details on printing, click the Help button in the Kodak EasyShare software.

For more information on printing from your computer or card, see [page 70](#).

Tagging Pictures and Videos for Emailing

First—On Your Computer

Use Kodak EasyShare software to create an email address book on your computer. Then, copy up to 32 email addresses to the camera's internal memory.

Second—Tag On Your Camera

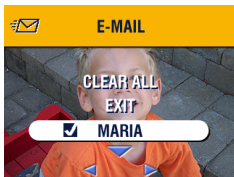

- 1 Press the Share button. Press $\blacktriangleleft/\blacktriangleright$ to locate a picture.
- 2 Highlight Email ✉ , then press the OK button.
- 3 Press $\blacktriangleup/\blacktriangledown$ to highlight an email address, then press the OK button.

To tag other pictures with the same address, press $\blacktriangleleft/\blacktriangleright$ to scroll through the pictures. When the picture you want is displayed, press OK.

To send the pictures to more than one address, repeat step 3 for each address.

Selected addresses are checked.

- 4 To remove a selection, highlight a checked address and press the OK button. To remove all email selections, highlight Clear All.
- 5 Press $\blacktriangleup/\blacktriangledown$ to highlight Exit, then press the OK button.

Your selections are saved. The email icon ✉ appears in the status area.

- 6 Press the Share button to exit the menu.

Third—Transfer and Email

When you transfer the tagged pictures and videos to your computer, the Kodak EasyShare software email screen opens and lets you send the pictures and videos to the addresses you specified. For details, click the Help button in the Kodak EasyShare software.

Tagging Pictures and Videos as Favorites

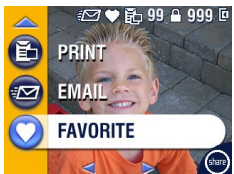

- 1 Press the Share button. Press \leftarrow/\rightarrow to locate a picture.
- 2 Press \uparrow/\downarrow to highlight Favorite \heartsuit , then press the OK button.

The Favorite icon \heartsuit appears in the status area.

- 3 To remove the tag, press the OK button again.
- 4 Press the Share button to exit the menu.

Using Favorites On Your Computer

When you transfer Favorite pictures and videos to your computer, you can use Kodak EasyShare software to retrieve, organize, and label them by subject, date, event, or any category you choose.

For details, click the Help button in the Kodak EasyShare software.



Need Help?

Click the Help button in the Kodak EasyShare software for details on creating address books, and printing, emailing, and organizing tagged pictures on your computer.











6 Customizing Your Camera Settings

Use Setup to customize camera settings according to your preferences.

To Access Setup Mode/Menus

- 1 In any mode (including Review), press the Menu button.
- 2 Press  to highlight Setup , then press the OK button.

Setup Menu

	Return to previous menu		Date & Time Set (page 6)
	Default Print Quantity (page 60)		Video Out (page 63)
	Quickview (page 60)		Language (page 63)
	Liveview (page 61)		Format (page 64)
	Advanced Digital Zoom (page 62)		About (page 64)
	Shutter Sound (page 62)		

Changing the Default Print Quantity

The Default Print Quantity setting determines the value that is displayed on the Share Print screen (page 56). The default value is 1.

- 1 Press the Menu button.
- 2 Press $\blacktriangle/\blacktriangledown$ to highlight Setup , then press the OK button.

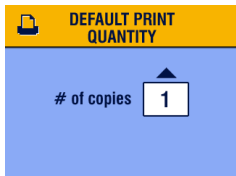



- 3 Press $\blacktriangle/\blacktriangledown$ to highlight Default Print Quantity , then press the OK button.
- 4 Press $\blacktriangle/\blacktriangledown$ to select the new default quantity, then press the OK button.
- 5 Press the Menu button to exit the menu.

This setting remains until you change it.

Turning Off Quickview

After you take a picture or video, Quickview displays it on the camera screen for approximately 5 seconds (see page 19 and page 40). To save battery power, turn off Quickview.

- 1 Press the Menu button.
- 2 Press $\blacktriangle/\blacktriangledown$ to highlight Setup , then press the OK button.
- 3 Press $\blacktriangle/\blacktriangledown$ to highlight Quickview , then press the OK button.

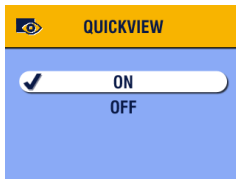

- 4 Press $\blacktriangle/\blacktriangledown$ to highlight Off, then press the OK button.
- 5 Press the Menu button to exit the menu.

The picture is not displayed on the camera screen after you take it. To see the picture or video, press the Review button. This setting remains until you change it.

Turning On Liveview in Still Modes

The Liveview feature lets you use the camera screen as a viewfinder (see [page 17](#)). The default setting is Liveview Off. You must press the OK button to turn it on.

IMPORTANT: *Liveview quickly depletes battery power; use it sparingly.*

To change the Liveview default to On:

- 1 Press the Menu button.
- 2 Press $\blacktriangle/\blacktriangledown$ to highlight Setup \equiv , then press the OK button.
- 3 Press $\blacktriangle/\blacktriangledown$ to highlight Liveview , then press the OK button.

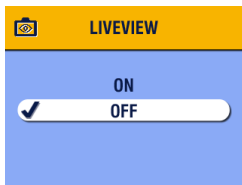

- 4 Press $\blacktriangle/\blacktriangledown$ to highlight On, then press the OK button.

Liveview is now On by default. The camera screen is on whenever the camera is on (in Still or Video mode). You can still press the OK button to turn Liveview off and on.

- 5 Press the Menu button to exit the menu.
This setting remains until you change it.

Changing Advanced Digital Zoom

- 1 Press the Menu button.
- 2 Press $\blacktriangle/\blacktriangledown$ to highlight Setup \equiv , then press the OK button.
- 3 Press $\blacktriangle/\blacktriangledown$ to highlight Advanced Digital Zoom , then press the OK button.
- 4 Press $\blacktriangle/\blacktriangledown$ to highlight an option:
 - Continuous**—digital zoom automatically turns on after the Telephoto button is pressed to the optical zoom limit and held.
 - Pause (default)**—digital zoom turns on after the Telephoto button is pressed to the optical zoom limit, released, then is pressed again.
 - None**—disables digital zoom.
- 5 Press the Menu button to exit the menu.

NOTE: Advanced Digital Zoom cannot be activated unless Liveview is on.

Turning Off the Shutter Sound

- 1 Press the Menu button.
- 2 Press $\blacktriangle/\blacktriangledown$ to highlight Setup \equiv , then press the OK button.
- 3 Press $\blacktriangle/\blacktriangledown$ to highlight Shutter Sound , then press the OK button.
- 4 Press $\blacktriangle/\blacktriangledown$ to highlight Off, then press the OK button.

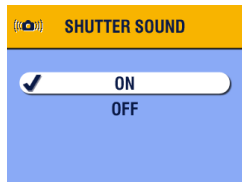
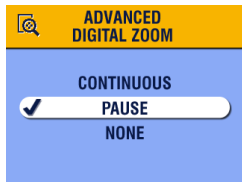

No sound plays when a picture is taken.
- 5 Press the Menu button to exit the menu.

This setting remains until you change it.



Setting Video Out

Video Out is a regional setting that lets you successfully connect to a television or other external device (see [page 52](#)).

- 1 Press the Menu button.
- 2 Press $\blacktriangle/\blacktriangledown$ to highlight Setup , then press the OK button.
- 3 Press $\blacktriangle/\blacktriangledown$ to highlight Video Out , then press the OK button.





- 4 Press $\blacktriangle/\blacktriangledown$ to highlight an option:
NTSC (default)—used in most countries except those in Europe and China. North America and Japan use NTSC.
PAL—used in Europe and China.
- 5 Press the OK button to accept the change.
- 6 Press the Menu button to exit the menu.

This setting remains until you change it.

Selecting a Language

You can display menus and screen messages in different languages.

- 1 Press the Menu button.
- 2 Press $\blacktriangle/\blacktriangledown$ to highlight Setup , then press the OK button.
- 3 Press $\blacktriangle/\blacktriangledown$ to highlight Language , then press the OK button.



- 4 Highlight an option, then press the OK button.
- 5 Press the Menu button to exit the menu.



*Text is displayed in the selected language.
 This setting remains until you change it.*

Formatting Internal Memory or SD/MMC Card



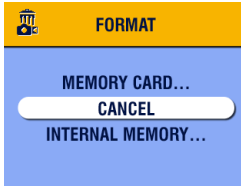

CAUTION:

Formatting erases all pictures and videos, including those that are protected. Removing a card during formatting may damage the card.

- 1 Press the Menu button.
 - 2 Press $\blacktriangle/\blacktriangledown$ to highlight Setup , then press the OK button.
 - 3 Press $\blacktriangle/\blacktriangledown$ to highlight Format , then press the OK button.
- 
- 4 Press $\blacktriangle/\blacktriangledown$ to highlight an option:
 - MEMORY CARD**—deletes everything on the card; formats the card.
 - CANCEL**—exits without making a change.
 - INTERNAL MEMORY**—deletes everything in internal memory including email addresses and album names; formats the internal memory.
 - 5 Press the OK button.
 - 6 Highlight Continue Format, then press the OK button.

When the formatting is complete, the Setup menu appears.

Viewing Camera Information

- 1 Press the Menu button.
- 2 Press $\blacktriangle/\blacktriangledown$ to highlight Setup , then press the OK button.
- 3 Press $\blacktriangle/\blacktriangledown$ to highlight About , then press the OK button.

The camera model and the current firmware version appear.
- 4 Press the Menu button to exit the menu.

7 Installing the Software

This product was designed and manufactured to existing industry standards as of this product's release date.

Future hardware and operating systems may or may not support this Kodak product. Please contact your hardware or operating system manufacturer or retailer if you encounter compatibility problems between this product and future hardware products or operating systems.

NOTE: To install software on computers running Windows 2000, Windows XP Pro operating systems, or Mac OS X, you need administrator privileges. See your computer user's guide.

Minimum system requirements

Windows OS-based computers	Macintosh computers
<ul style="list-style-type: none"><input type="radio"/> Windows 98, 98SE, ME, 2000 SP1, or XP OS<input type="radio"/> Internet Explorer 5.01 or higher<input type="radio"/> 233 MHz processor or greater<input type="radio"/> 64 MB RAM (128 MB RAM for Windows XP OS)<input type="radio"/> 200 MB hard disk space available<input type="radio"/> CD-ROM drive<input type="radio"/> Available USB port<input type="radio"/> Color monitor, 800 x 600 pixels (16-bit or 24-bit recommended)	<ul style="list-style-type: none"><input type="radio"/> Power Mac G3, G4, G5, G4 Cube, iMac; PowerBook G3, G4; or iBook computers<input type="radio"/> Mac OS X version 10.2.3, 10.3<input type="radio"/> Safari 1.0 or higher<input type="radio"/> 128 MB RAM<input type="radio"/> 200 MB hard disk space available<input type="radio"/> CD-ROM drive<input type="radio"/> Available USB port<input type="radio"/> Color monitor, 1024 x 768 pixels (thousands or millions of colors recommended)

NOTE: Mac OS 8.6 and 9.x do not support the Share button functions,

including Favorites. Mac OS X version 10.2.x or 10.3 is recommended for full functionality. To download EasyShare software for Mac OS 8.6 and 9.x, visit

www.kodak.com/go/cx6445downloads.

Install the Software

For information on the software applications included on the Kodak EasyShare software CD, click the Help button in the Kodak EasyShare software.

NOTE: Computers with Windows 2000, Windows XP Pro, or Mac OS X operating systems need administrator privileges to install the software. See your computer user's guide.



CAUTION:

Install the software from the Kodak EasyShare software CD *before* connecting the camera or optional camera dock to the computer. Failure to do so may cause the software to load incorrectly.





- 1 Before you begin, close all software applications that are open on your computer (including anti-virus software).
 - 2 Place the Kodak EasyShare software CD into the CD-ROM drive.
 - 3 Load the software:
Windows OS-based computer—if the install window does not appear, choose Run from the Start menu and type **d:\setup.exe** where **d** is the drive letter that contains the CD.
Mac OS X—double-click the CD icon on the desktop, then click the Install icon.
 - 4 Follow the on-screen instructions to install the software.
 - **Windows OS-based computers**—select Complete to automatically install all applications. Select Custom to choose the applications you wish to install.
 - **Mac OS X**—follow the on-screen instructions.
- NOTE:** When prompted, take a few minutes to electronically register your camera and software. This lets you receive information regarding software updates and registers some of the products included with the camera. You must be connected to your Internet service provider to register electronically.
- To register later, visit www.kodak.com/go/register.
- 5 Restart the computer. If you turned off anti-virus software, turn it back on. See the anti-virus software manual for details.

8 Connecting Camera to Computer



CAUTION:

Install Kodak EasyShare software before connecting the camera or optional dock to the computer. Failure to do so may cause the software to load incorrectly.

You can transfer pictures and videos from the camera to the computer using:

- The (included) USB cable.
- The (optional) Kodak EasyShare camera dock 6000. See [page 73](#) for connecting with the camera dock.
- The (optional) Kodak EasyShare printer dock 6000. Purchase these and other accessories at a dealer of Kodak products or visit www.kodak.com/go/cx6445accessories.

Transferring Pictures With the USB Cable

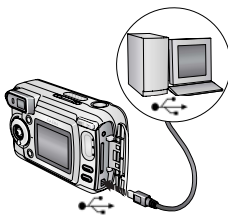

- 1 Turn off the camera.
- 2 Plug the labeled  end of the USB cable into the labeled USB port on your computer. See your computer user's guide for details.
- 3 Plug the other end of the USB cable into the labeled USB port on the camera.
- 4 Turn on the camera.

Kodak EasyShare software opens on your computer. The software prompts you through the transfer process.

NOTE: Visit www.kodak.com/go/howto for an online tutorial on connecting.

You can also use a Kodak multi-card reader or Kodak SD multimedia card reader-writer to transfer your pictures.

Printing Pictures from Your Computer

For details on printing pictures from your computer, click the Help button in the Kodak EasyShare software.

Ordering Prints Online

Kodak EasyShare print service (provided by Ofoto www.ofoto.com) is one of the many online print services offered in the Kodak EasyShare software. You can easily:

- Upload your pictures.
- Edit, enhance, and add borders to your pictures.
- Store pictures, and share them with family and friends.
- Order high-quality prints, photo greeting cards, frames, and albums—and have them delivered to your door.

Printing From an Optional SD/MMC Card

- Automatically print tagged pictures when you insert your card into a printer with an SD/MMC slot. See your printer user's guide for details.
- Make prints at an SD/MMC-capable Kodak picture maker. (Visit www.kodak.com/go/picturemaker.)
- Take the card to your local photo retailer for professional printing.

Print With or Without a Computer

Dock your camera to the Kodak EasyShare printer dock 6000 and print directly—without using a computer. Purchase this and other accessories at a dealer of Kodak products or visit www.kodak.com/go/cx6445accessories.

9 Using the Camera Dock 6000

The Kodak EasyShare camera dock 6000:

- Makes it easy to transfer pictures and videos to the computer.
- Charges the included Kodak EasyShare Ni-MH rechargeable battery pack. (Install the battery pack in the camera for charging.)
- Supplies power to the camera.

You can purchase a camera dock at a dealer of Kodak products or visit www.kodak.com/go/cx6445accessories.

Camera Dock 6000 Package Contents

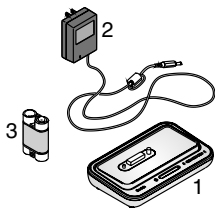

1 Camera dock 6000 (with universal insert installed)

2 AC power adapter, 5-volt

Your AC adapter may differ from the one pictured.

3 Kodak EasyShare Ni-MH rechargeable battery pack

4 Quick Start Guide (not shown)



CAUTION:

Do not use the AC power adapter, 5-volt to power your camera without the dock. It is not compatible with your camera alone.

Installing the Custom Camera Insert

A **universal insert** is pre-installed in the camera dock. It allows all Kodak EasyShare CX/DX6000/7000 series and LS600/700 series cameras to use the camera dock.

A **custom insert** is included with your camera. It provides a perfect fit for your Kodak EasyShare CX6445 zoom digital camera.

Remove the Universal Insert

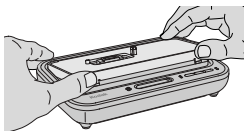

- 1 Place your thumbs against the front of the universal insert. Press in and lift.

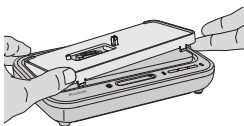

- 2 Lift the side edge of the insert, then remove the insert from the dock.
- 3 Save the universal insert as a spare.

Install the Custom Insert

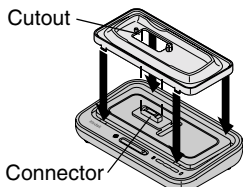

- 1 Position the custom insert so the cutout lines up with the camera dock connector.
- 2 Fit the insert into the groove in the dock. Snap it into place.

NOTE: To order a custom insert for your camera, visit www.kodak.com/go/cx6445accessories.

Connecting the Camera Dock 6000

After the Kodak EasyShare software is loaded (see [page 66](#)), connect the camera dock to your computer and to a power outlet. You need:

- The USB cable included with your camera
- The AC adapter, 5-volt included with the camera dock

IMPORTANT: *Make sure your camera is NOT in the camera dock when you are connecting to power and the computer.*

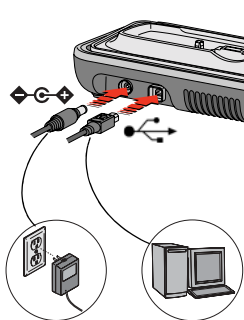

- 1 Plug the labeled  end of the USB cable into the labeled USB port on your computer. See your computer user's guide for details.
- 2 Plug the other end of the USB cable into the square USB connector on the back of the camera dock.
- 3 Plug the AC adapter into the round power connector on the back of the camera dock and into a power outlet.

Your AC adapter may differ from the one pictured or may have additional plugs. Use the plug that accommodates your type of power outlet.

IMPORTANT: *Use only the AC adapter, 5-volt included with the camera dock 6000. Other adapters may cause damage to your camera, camera dock, or AC adapter.*

Leave the camera dock connected so it's always ready to transfer pictures and videos.

Installing the Rechargeable Battery

You received a non-rechargeable CRV3 starter battery with your camera. To take full advantage of your camera dock 6000, replace the CRV3 battery with the Kodak EasyShare Ni-MH rechargeable battery pack that is packaged with the camera dock.

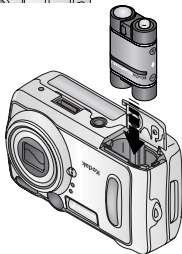

- 1 Open the battery door on the bottom of the camera.
- 2 Install the Ni-MH rechargeable battery pack as illustrated.



CAUTION:

The battery pack can only be inserted into the camera in the orientation shown. If the battery pack does not easily install, reposition it and try again. **DO NOT FORCE IT.** Doing so can damage your camera.

- 3 Close the battery door.

IMPORTANT: *The battery pack is not charged when you receive it. See [page 76](#) for charging instructions.*

Docking the Camera

To charge the battery or to transfer pictures and videos from the camera to the computer:

Alignment

Pins

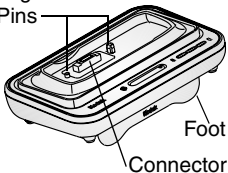

- 1 Flip down the camera dock foot.

The camera dock now sits at the proper angle for viewing the camera screen.

- 2 Turn off the camera.

- 3 Match the connector and alignment pins on the camera dock to the camera. Push down until the camera is securely seated.

The Transfer light glows green when the camera is seated.

If a rechargeable battery is in the camera, the first battery charging light glows green.

The camera is now powered by the camera dock instead of the camera batteries.

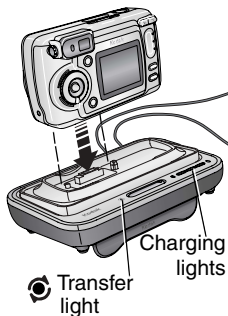

NOTE: If the Kodak EasyShare Ni-MH rechargeable battery pack requires charging, charging begins (see [page 76](#)).

Charging the Battery







Charging lights

- 1 Make sure the Kodak EasyShare Ni-MH rechargeable battery pack is installed in the camera (see [page 74](#)).
- 2 Turn off the camera and place it in the camera dock (see [page 75](#)).

If the battery requires charging, charging begins after a brief battery check.

- Full charging takes about 2.5 hours.
- Charging stops if you turn on the camera. If the camera is left in the camera dock with the power on, charging resumes when the camera enters auto power-off (see [page 107](#)).
- Charging is suspended during picture transfer.

Charging Lights Status

Charging Lights	Cause
Green lights   	Camera is properly docked. Battery is either being checked or is less than half charged. Battery is more than half charged. Battery is fully charged.
Red light (blinking) 	Battery is not properly installed (see page 74). Battery or connector pin is damaged. Camera and battery have been exposed to extreme temperatures. Slowly return to room temperature.
No lights	Camera is not properly seated in the camera dock. AC adapter is not connected. Rechargeable battery is not installed (see page 74).

Transferring Pictures With the Dock

After the Kodak EasyShare software is loaded on your computer (see [page 66](#)), you can transfer pictures and videos from your camera to your computer.

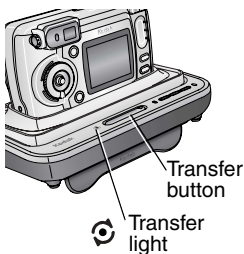

- 1 Turn off the camera and place it in the camera dock.
- 2 Push the Transfer button.

The Transfer light blinks green while the pictures and videos are transferring.

Messages about the transfer status appear on the camera screen. Kodak EasyShare software automatically opens on your computer.

NOTE: After transferring, the camera dock resumes charging as necessary.

Transfer Light Status

Light	Cause
Steady	The camera is properly seated in the camera dock. The camera dock is connected to AC power and to a computer via the USB cable.
Blinking	Pictures are being transferred to the computer.
Off	The camera is not seated in the camera dock (page 75).
	The camera dock is not plugged into AC power (page 73).
	The USB cable is not connected (page 73).

Need Help Using the Software?

For details on transferring, organizing, printing, emailing, and editing your pictures, click the Help button in the Kodak EasyShare software screens.

Reviewing Pictures and Videos

When the camera is in the dock, the camera is powered by the dock, not the camera batteries. Save battery power by using the dock to review pictures and videos on the camera screen.



- 1 Turn on the camera and place it in the camera dock.
- 2 Press the Review button to display the last picture or video taken. See [Chapter 4, Reviewing Pictures and Videos](#), for details.

You can perform any camera function with the camera in the dock (ex., run a slide show, check or change settings).

Camera Dock 6000 Specifications

Specifications—Kodak EasyShare camera dock 6000		
Communication with computer	USB	Cable (included with Kodak EasyShare cameras)
Dimensions (without insert)	Width	6.1 in. (155 mm)
	Depth	3.7 in. (94.5 mm)
	Height	1.2 in. (31 mm)
	Weight	6.0 oz (170 g)
Transfer light (page 77)		Indicates connection/transfer
Charging lights (page 76)		Indicate charging status and error conditions
Input voltage		5 ±0.25 V DC
Power	DC input	AC adapter (included with camera dock)

Troubleshooting—Camera Dock 6000

Problem	Cause	Solution
Cannot transfer pictures to the computer.	Software is not installed.	Disconnect USB cable and remove camera from dock. Install EasyShare software (page 66).
	Software is installed incorrectly.	Disconnect the USB cable and remove camera from dock. Close all open applications. Uninstall, then re-install the software (page 66). To uninstall, go to Start/Settings/ Control Panel/Add/Remove Programs.
	USB cable was connected during software installation. Camera is listed as an unknown device (PC only).	Disconnect the USB cable and remove camera from dock. Delete camera from Device Manager: Right-click on My Computer, go to Properties/ Hardware/Device Manager/Other Devices/ (delete this entry— <i>?Kodak ES camera</i>)
	AC adapter or USB cable is not securely connected.	Check the connections (page 73).
	Too many applications running on computer.	Close all software applications and try again.
	Camera was removed from the camera dock during picture transfer.	Replace the camera on the camera dock and press the Transfer button.
	Transfer button was not pressed.	Press the Transfer button.

Earlier Cameras and Docks

Your Kodak EasyShare camera dock 6000 requires a Kodak EasyShare CX/DX6000/7000 or LS600/700 series digital camera.

Earlier camera models (Kodak EasyShare 4000 series and previous) require the original Kodak EasyShare camera dock or camera dock II.

10 Troubleshooting

When you have questions about your camera, start here. Additional technical information is available in the ReadMe file located on the Kodak EasyShare software CD. For camera dock 6000 troubleshooting, see [page 79](#). For updates to Troubleshooting information, visit www.kodak.com/go/cx6445support.

Camera Problems

Problem	Cause	Solution
Camera does not turn on.	Battery is not properly installed.	Reinstall the battery (page 4).
	Battery is not charged.	Recharge the battery (page 76).
Camera does not turn off; lens does not retract.	A non-approved battery may be in the camera.	Use the battery that came with your camera, or an approved replacement battery (page 12).
Pictures remaining number does not decrease after taking a picture.	The picture does not take up enough space to decrease the number.	The camera is operating normally. Continue taking pictures.
	You did not take a picture.	Use Review (page 45) or Quickview (page 19) to make sure a picture was taken.
Picture orientation is not accurate.	The camera was rotated or tilted while the picture was taken.	Set the Orientation Sensor (page 37).

Problem	Cause	Solution
Shutter button does not work.	Camera is not turned on.	Turn on the camera (page 5).
	The camera is processing a picture; the ready light (near the viewfinder) is blinking.	Wait until the ready light stops blinking before attempting to take another picture.
	The card or internal memory is full.	Transfer pictures to the computer (page 69), delete pictures from the camera (page 47), switch storage locations (page 10), or insert a card with available memory (page 9).
	The Shutter button was not pressed.	For best pictures, see page 15.
Part of the picture is missing. (Also see Stored pictures are corrupted.)	Something was blocking the lens when the picture was taken.	Keep hands, fingers, or other objects away from the lens when taking pictures.
	Your eye or the picture was not centered correctly in the viewfinder or camera screen.	Leave space around subject when centering picture in viewfinder or camera screen.
Stored pictures are corrupted.	The card was removed or the battery expired while the ready light was blinking.	Retake picture. Do not remove card while the ready light is blinking. Keep battery charged.

Problem	Cause	Solution
In Review mode, you do not see a picture (or the expected picture) on the camera screen.	The camera may not be accessing the correct storage location.	Check the picture storage location setting (page 10).
Picture is too dark.	Flash is not on.	Turn on the flash (page 21).
	The subject is too far away for the flash to have an effect.	Move so there is no more than 16.7 ft (5.1 m) between the camera and the subject; 8.5 ft (2.6 m) in Telephoto.
	The subject is in front of a bright light (backlit).	Use Fill flash (page 21) or change your position so light is not behind the subject.
	Not enough light.	In Landscape mode, use Long Time Exposure (page 32). In Landscape or Close-up modes, set ISO to 400 (page 31).
	Auto exposure was not achieved.	To take the best possible pictures, press the Shutter button half-way and hold . When the ready light glows green, press the Shutter button the rest of the way down to take the picture.

Problem	Cause	Solution
Picture is too light.	The flash is not needed.	Change to Auto flash or Flash Off (page 21).
	The subject was too close for flash.	Move so there is at least 1.6 ft (0.5 m) in Wide; 2.5 ft. (0.75 m) in Tele between camera and subject.
	The light sensor is covered.	Hold the camera so your hands or other objects do not cover the light sensor.
	Too much light.	Decrease Exposure Compensation (page 27).
	Auto exposure was not achieved.	To take the best possible pictures, press the Shutter button half-way and hold . When the ready light glows green, press the Shutter button the rest of the way down to take the picture.
In Review mode, a blue screen is displayed instead of a picture.	The picture has no thumbnail or an unrecognized thumbnail.	Transfer the picture to the computer (page 69), or delete the picture (page 47).
Stored pictures are damaged.	The card was removed when the ready light was blinking.	Make sure the ready light is not blinking before removing the card.

Problem	Cause	Solution
Picture is not clear.	The lens is dirty.	Clean the lens (page 103).
	Subject too close when taking picture.	Move so there is at least 19.7 in. (50 cm) between the camera and the subject, or at least 3.9 in. (10 cm) at Wide in Close-up mode.
	Subject or the camera moved while the picture was taken.	Place the camera on a flat, steady surface or use a tripod.
	The subject is too far away for the flash to be effective.	Move so there is no more than 16.7 ft (5.1 m) between the camera and the subject; 8.5 ft (2.6 m) in Telephoto.
	Auto focus was not achieved.	To take the best possible pictures, press the Shutter button half-way and hold . When the ready light glows green, press the Shutter button the rest of the way down to take the picture. (If the yellow light blinks, release the Shutter button and recompose picture.)
Slide show does not run on external video device.	Video Out setting is incorrect.	Adjust the camera Video Out setting (NTSC or PAL, page 63).
	External device is set incorrectly.	See the external device's user's guide.
Camera freezes up when a card is inserted or removed.	Camera detected an error when the card was inserted or removed.	Turn the camera off, then back on. Make sure the camera is turned off before inserting or removing a card.

Camera/Computer Communications

Problem	Cause	Solution
The computer cannot communicate with the camera. (For communication problems with a camera dock 6000, see page 79 .)	There is a problem with the configuration of the USB port on the computer.	See this file on the EasyShare software CD: USB.html Or visit: www.kodak.com/go/camerasupport
	Camera power is off.	Turn on the camera (page 5).
	Battery is not charged.	Recharge the battery (page 76).
	Some Advanced Power Management utilities on laptops turn off ports to save battery life.	See the Power Management section of the laptop user's guide to disable this feature.
	USB cable is not securely connected.	Connect cable to camera and computer port (page 69).
	Software is not installed.	Install the software (page 66).
	Software is installed incorrectly.	Disconnect the USB cable. Close all open applications. Uninstall, then re-install the software (page 66). To uninstall, go to Start/Settings/Control Panel/Add/Remove Programs.
	Too many applications are running on the computer.	Disconnect camera from the computer. Close all software applications, reconnect camera.
The Battery Monitor or similar software runs constantly.	Close that software before starting the Kodak software.	

Problem	Cause	Solution
Cannot transfer pictures. (The Add New Hardware Wizard cannot locate drivers.)	Software is not installed.	Disconnect USB cable. (If using camera dock, disconnect cable and remove camera from dock). Install EasyShare software (page 66).
	Software is installed incorrectly.	Disconnect the USB cable. Close all open applications. Uninstall, then re-install the software (page 66). To uninstall, go to Start/Settings/Control Panel/Add/Remove Programs.
	USB cable was connected during software installation. Camera is listed as an unknown device (PC only)	Disconnect the USB cable. Delete camera from Device Manager: Right-click on My Computer, go to Properties/Hardware/Device Manager/Other Devices/ (delete this entry— ?Kodak ES camera)

SD/MMC Cards and Internal Memory

Problem	Cause	Solution
The camera does not recognize SD/MMC card.	The card may not be SD/MMC certified.	Purchase a certified SD/MMC card.
	The card may be corrupt.	Reformat the card (page 64). Caution: Formatting erases all pictures and videos, including protected files.
	Card is not properly inserted in camera.	Insert a card into the slot, then push to seat (page 9).

Problem	Cause	Solution
Camera freezes up when a card is inserted or removed.	Camera detects an error when the card was inserted or removed.	Turn the camera off, then back on. Make sure the camera is off when inserting or removing a card.
Memory card full	Storage is full.	Transfer pictures and videos to the computer, then delete them from the camera.
	The maximum number of files or folders is reached (or other directory concern).	Transfer pictures and videos to the computer, then format the card or internal memory (page 64). Caution: Formatting a card erases all pictures and videos, including protected files. (Formatting internal memory also erases email addresses and album names. To restore addresses and albums, see Kodak EasyShare software Help.)

Camera Screen Messages

Message	Cause	Solution
No images to display	There are no pictures in the current storage location.	Change picture storage location setting (page 10).
Memory card requires formatting	The card is corrupted or formatted for another digital camera.	Insert a new card or format the card (page 64).
Memory card cannot be read (Please format card or insert another card)		Caution: Formatting erases all pictures and videos, including protected files.

Message	Cause	Solution
Internal memory requires formatting	The camera internal memory is corrupted.	Format the internal memory (page 64).
Internal memory cannot be read (Please format internal memory)		Caution: Formatting erases all pictures and videos, including protected files. (Formatting internal memory also erases email addresses and album names. To restore them, see Kodak EasyShare software Help.)
No memory card (Files not copied)	There is no card in the camera. Pictures were not copied.	Insert a card (page 9).
Not enough space to copy files (Files not copied)	There is not enough space in the location you are copying to (internal memory or the card).	Delete pictures from the location you are copying to (page 47), or insert a new card.
Read-only card, change to internal memory to capture	The card in the camera is write-protected.	To take a picture, insert a new card or change storage location to internal memory (page 10).
Card is protected (Reset switch on card)	Switch on card is in write-protect position.	Reset the switch as shown on camera screen.
Card is locked (Insert a new card)	The card is write-protected.	To take a picture, insert a new card or change storage location to internal memory (page 10).

Message	Cause	Solution
Card is unusable (Insert a new card)	The card is slow, corrupted, or unreadable.	Insert a new card (page 9).
Recording stopped. Record in internal memory (Card speed is slow)	Card cannot be used to take videos.	Change storage location to internal memory (page 10). Use this card to take pictures only.
Memory card is full (Cannot save Share/Album tagging)	There is no space remaining.	Insert a new card (page 9), transfer pictures (page 69), or delete pictures (page 47).
Internal memory is full (Cannot save Share/Album tagging)		
Date and time have been reset	This is the first time you turned on the camera; or the battery has been removed for an extended period of time; or the battery is exhausted.	Reset the clock (page 6).
High camera temperature. (Camera will be turned off.)	The internal temperature of the camera is too high for the camera to operate. The viewfinder light glows red and the camera turns off.	Leave the camera off for several minutes, then turn it back on. If the message reappears, contact Customer Support (page 96).

Message	Cause	Solution
Memory Card is full	There is no more space on the card in the camera.	Transfer pictures to the computer (page 69), delete pictures from the card (page 47), insert a new card, or change storage location to internal memory (page 10).
Internal Memory is full	There is no more space in the camera's internal memory.	Transfer pictures to the computer (page 69), delete pictures from the internal memory (page 47) or change storage location to Auto (page 10) and insert card (page 9).
Unrecognized File Format	The camera cannot read the picture format.	Transfer the unreadable picture to the computer (page 69), or delete the picture (page 47).
No Address Book in Camera	No email addresses appear because there is no address book.	Create and copy address book from computer. See EasyShare software Help.
No Album Names in Camera	Album names have not been copied to the camera from the computer.	Create and copy album names from computer. See EasyShare software Help.
Other error code	An error is detected.	Turn the Mode dial off, then back on. If the message reappears, contact Customer Support (page 96).

Camera Ready Light Status



Status	Cause	Solution
Ready light does not turn on and the camera does not work.	Camera is not turned on.	Turn on the camera (page 5).
	Battery is exhausted.	Recharge the battery (page 76) or install a new one (page 4).
	Mode dial was on when battery was reloaded.	Turn Mode dial off, then back on.
Ready light glows steady green.	Camera is on; ready to take a picture or video.	Camera is operating normally.
	Shutter button is pressed halfway down. Focus and exposure are set.	Camera is operating normally.
Ready light blinks green.	Picture is being processed and saved to the camera.	Camera is operating normally.

Status	Cause	Solution
Ready light blinks yellow.	Flash is not charged.	Wait. Resume picture taking when the light stops blinking and turns green.
	Auto exposure or auto focus are not locked.	Release the Shutter button and recompose the picture.
Ready light blinks red.	Battery is low or exhausted.	Recharge the battery (page 76) or install a new one (page 4).
Ready light glows steady red.	Camera's internal memory or card is full.	Transfer pictures to the computer (page 69), delete pictures from the camera (page 47), switch storage locations (page 10), or insert a card with available memory (page 9).
	Camera processing memory is full.	Wait. Resume picture taking when the light turns green.
	Card is read-only.	Change storage location to internal memory (page 10), or use a different card.

11 Getting Help

Helpful Web Links

Help with your camera	www.kodak.com/go/cx6445support
Help with Windows operating system and working with digital pictures	www.kodak.com/go/pcbasics
Download the latest camera software and firmware	www.kodak.com/go/cx6445downloads
Optimize your printer for truer, more vibrant colors	www.kodak.com/go/onetouch
Get support for cameras, software, accessories, more	www.kodak.com/go/support
Purchase camera accessories	www.kodak.com/go/cx6445accessories
Register your camera	www.kodak.com/go/register
View online tutorials	www.kodak.com/go/howto

Help in this Manual

See [Troubleshooting, page 81](#) for help with problems you may have with your camera, camera/computer connections, or SD/MMC cards. See [page 71](#) for help with the EasyShare camera dock 6000.

Software Help

Click the Help button in the Kodak EasyShare software.

Telephone Customer Support

If you have questions concerning the operation of the software or camera, you may speak with a customer support representative.

Before You Call

- Have the camera or camera dock connected to your computer.
- Be at your computer.
- Have the following information available:

Operating system _____

Processor speed (MHz) _____

Computer model _____

Amount of memory (MB) _____

Exact error message you received _____

Version of Kodak EasyShare software CD _____

Camera serial number _____

Telephone Numbers

Australia	1800 147 701
Austria/Osterreich	0179 567 357
Belgium/Belgique	02 713 14 45
Brazil	0800 150000
Canada	1 800 465 6325
China	800 820 6027
Denmark/Danmark	3 848 71 30
Ireland/Eire	01 407 3054
Finland/Suomi	0800 1 17056
France	01 55 1740 77
Germany/Deutschland	069 5007 0035
Greece	00800 441 25605
Hong Kong	800 901 514
India	91 22 617 5823
Italy/Italia	02 696 33452
Japan	03 5644 5050
Korea	00798 631 0024
Netherlands/Nederland	020 346 9372
New Zealand	0800 440 786
Norway/Norge	23 16 21 33
Philippines	1 800 1 888 9600
Portugal	021 415 4125
Singapore	800 6363 036

Spain/Espana	91 749 76 53
Sweden/Sverige	08 587 704 21
Switzerland/Schweiz/Suisse	01 838 53 51
Taiwan	0 080 861 008
Thailand	001 800 631 0017
UK	0870 243 0270
United States	1 800 235 6325
Outside the United States	585 726 7260
International Toll Line	+44 131 458 6714
International Toll Fax	+44 131 458 6962

For the most up-to-date listings, visit:

<http://www.kodak.com/US/en/digital/contacts/DAIInternationalContacts.shtml>

12 Appendix

Camera Specifications

Kodak EasyShare CX6445 zoom digital camera		
Color		24-bit, millions of colors
Color modes		Color, black & white, sepia
Communication with computer		USB, via: USB cable; EasyShare camera dock 6000; or printer dock 6000
Dimensions	Width	4.3 in. (109 mm)
	Depth	1.5 in. (38 mm)
	Height	2.5 in. (64.5 mm)
	Weight	7.8 oz (220 g) with battery and card
Exposure metering		Multi-pattern/Center weighted, center spot TTL-AE with program modes
File format	Still	JPEG/EXIF v2.2 Exif Print
	Video	QuickTime
	Audio	G.711
Flash	Modes	Auto, Fill, Red-eye, Off
	Range	Wide: 1.6-16.7 ft (0.5-5.1 m) f/2.4 Tele: 2.5-8.5 ft (0.75-2.6 m) f/4.8
	Charging Time	Less than 9.0 seconds with charged battery
Focus zone		Multi-zone, center zone
Image sensor	1/2.5 in. interline transfer CCD, 4:3 aspect ratio, RGB Bayer CFA, 4.23 M pixels (2408 x 1758 pixels)	

Kodak EasyShare CX6445 zoom digital camera

ISO speed	Automatic	100 to 200
	Manual	100, 200, or 400
	Long time exposure	100
	Flash	120 or 180 (Automatic)
	Video	100 to 800
Lens	Type	Optical quality glass, 6 groups/7 elements (2 aspherical lenses)
	Aperture	Wide: f/2.2 - f/5.6; Tele: f/4.8 - f/13
	Focal Length	33 - 132 mm
	Focus Distance	Standard Wide: 19.7 in. (50 cm) to infinity Standard Tele: 29.5 in. (75 cm) to infinity Close-up Wide: 3.9 to 23.6 in. (10 cm to 60 cm) Close-up Tele: 9.8 to 33.5 in. (25 cm to 85 cm) Landscape: Fixed focus
Liquid Crystal Display, LCD (Camera screen)		1.8 in. (45.7 mm), color, 560 x 240 (134k) pixels. Preview rate: 24 fps
Operating Temperature		32 to 104 ^o F (0 to 40 ^o C)
Picture/Video storage		16 MB internal; optional SD Card or MMC
Pixel resolution	Best ★★★	2304 x 1728 (4.0 M) pixels
	Best (3:2) ★★★	2304 x 1536 (3.5 M) pixels
	Better ★★	1656 x 1242 (2.1 M) pixels
	Good ★	1200 x 900 (1.1 M) pixels

Kodak EasyShare CX6445 zoom digital camera

Power	Battery: CRV3 (included), 2-AA lithium, 2-AA Ni-MH, Ni-MH rechargeable battery pack (included with camera dock 6000 and printer dock 6000)	
	AC adapter: 3V DC (purchase separately)	
Self Timer	10 seconds	
Tripod socket	Yes	
Video Out	NTSC or PAL selectable	
Video resolution	320 x 240 pixels, 15 fps	
Viewfinder	Optical, with diopter adjustment	
White balance	Auto, Daylight, Tungsten, Fluorescent	
Zoom (still capture)	4X optical, 3.8X digital	

Shutter Speeds

For shutter speeds slower than 1/30 second, place the camera on a flat, steady surface or use a tripod.

Picture Taking Mode	Available Shutter Speeds
Auto, Portrait, Landscape*, Close-up	Wide: 1/2200-1/60 sec., Tele: 1/2200-1/125 sec. Wide: 1/2200-1/8 sec., Tele: 1/2200-1/8 sec. (Flash: Off) *Long Time Exposure: 4 sec. max. (Landscape only)
Night	1/2200 to 1/2 sec.
Sport	Wide: 1/2200 to 1/60 sec., Tele: 1/2200 to 1/125 sec. Wide: 1/2200 to 1/30 sec., Tele: 1/2200 to 1/60 sec. (Flash: Off)

Original Factory Settings

Feature	Factory Setting
Adv. Digital Zoom initiation	Pause
Color Mode	Color
Date/Time	2003/01/01; 12:00
Date/Time Stamp	Off
Default Print Quantity	1
Exposure Compensation	0.0
Exposure Metering Mode	Multi-pattern
Flash	Auto, Sport, Portrait, Night: Auto Landscape, Close-up, Video, Burst: Off
Focus Zone	Multi-zone
Image Storage	Auto
ISO Speed	Auto
Language	English
Liveview	Off
Long Time Exposure	None
Orientation Sensor	On
Picture Quality	Best
Quickview	On
Set Album (Still)	Off
Shutter Sound	On
Slide Show Interval	5 seconds
Slide Show Loop	Off

Feature	Factory Setting
Storage Location	Auto
Video Date Display	None
Video Out	NTSC
White Balance	Auto

Upgrading Your Software and Firmware

Download the latest versions of the software included on the Kodak EasyShare software CD and the camera firmware (the software that runs on the camera). Visit www.kodak.com/go/cx6445downloads.

Tips, Safety, Maintenance

- Always follow basic safety precautions. Refer to the “Important Safety Instructions” booklet packed with your camera.
- Do not allow chemicals, such as suntan lotion, to come into contact with the painted surface of the camera.
- If the camera has been subjected to inclement weather or you suspect water has gotten inside the camera, turn off the camera and remove the battery and card. Allow all components to air-dry for at least 24 hours before using the camera again. If this does not resolve the problem, contact customer support ([page 96](#)).
- Clean the lens and camera screen:
 - 1 Blow gently on the lens or camera screen to remove dust and dirt.
 - 2 Wipe the lens or camera screen gently with a soft, lint-free cloth or an untreated lens-cleaning tissue.

Do not use cleaning solutions unless they are designed specifically for camera lenses. **Do not wipe the camera lens or camera screen with chemically treated eyeglass lens tissue. It may scratch the lens.**

- Wipe the outside of the camera with a clean, dry cloth. Never use harsh or abrasive cleaners or organic solvents on the camera or any of its parts.
- Connect a tripod directly to the camera; do not connect a tripod to the camera dock.
- Service agreements are available in some countries. Contact a dealer of Kodak products for more information.
- For digital camera disposal or recycling information, contact your local authorities. In the US, visit the Electronics Industry Alliance Web site at www.eiae.org or the Kodak Web site at www.kodak.com/go/cx6445support.

Storage Capacities

File sizes can vary. You may be able to store more or fewer pictures and videos. Purchase accessories at a dealer of Kodak products or visit www.kodak.com/go/cx6445accessories.

Video Storage Capacity 	Minutes/seconds of video
16 MB internal memory	1 min., 21 sec.
16 MB SD/MMC	1 min., 21 sec.
32 MB SD/MMC	2 min., 50 sec.
64 MB SD/MMC	5 min., 40 sec.
128 MB SD/MMC	11 min., 40 sec.
256 MB SD/MMC	23 min.

Picture Storage Capacity 	Number of pictures			
	Best ★★★	Best (3:2) ★★★	Better ★★★	Good ★
16 MB internal memory	13	16	25	45
16 MB SD/MMC	12	16	24	43
32 MB SD/MMC	25	32	48	87
64 MB SD/MMC	51	65	97	175
128 MB SD/MMC	103	131	194	350
256 MB SD/MMC	207	262	389	701

Locating Pictures and Videos on a Card

Pictures stored on SD/MMC Cards use a standard (DCF-Digital Camera Format) agreed upon by many camera manufacturers. This lets you use the cards in different cameras. If you use a card reader to retrieve your files, the following description of the card file structure may be helpful.

MISC folder—contains the order files created when you use the Share feature to tag files for printing, emailing, and as favorites; also contains the address book and album names copied from the computer.

SYSTEM folder—created and used while updating camera firmware.

DCIM folder—root level folder, contains the 100K6445 folder. Each time you turn on the camera or insert a different card, any empty folders within the DCIM folder are removed.

100K6445 subfolder—initially contains all pictures and videos on the card. Album tags are stored here with the picture or video.

Picture Naming Conventions

- Pictures are named 100_nnnn.JPG, and are numbered in the order in which they are taken. The first picture is named 100_0001.JPG; the highest number allowed is 100_9999.JPG.
- When a card contains a picture named 100_9999.JPG in the \DCIM\100K6445 folder, subsequent pictures appear in a new folder (\DCIM\101K6445), beginning with picture 101_0001.JPG.
- Even if you transfer pictures to the computer or delete pictures from the camera, the camera continues to use consecutive numbers for all subsequent pictures. For example, if the last picture taken was 100_0007.JPG and you delete it, the next picture you take is named 100_0008.JPG.
- When you insert a different card into your camera, the next picture number is defined by incrementing the higher of the last picture taken by the camera, or the highest existing picture number in the folder.
- If you use the card in a camera other than the Kodak EasyShare CX6445 zoom digital camera, and that camera manufacturer adheres to this file structure standard, the \DCIM folder contains a folder named by that camera. For more information, refer to the documentation that accompanied that camera.

Burst Pictures

When a burst series is initiated, a letter “B” replaces the underscore in the file name. When a burst series is initiated or ended, the second digit to the left of the decimal is incremented by 1.

Image	Mode	File name	Image	Mode	File name
1	Still	100_0001.JPG	4	Burst (1/2)	100B0020.JPG
2	Burst (1/2)	100B0010.JPG	5	Burst (2/2)	100B0021.JPG
3	Burst (2/2)	100B0011.JPG	6	Still	100_0030.JPG

Power-Saving Features

If No Activity For	The Camera	To Turn It Back On
1 minute	screen turns off.	Press the OK button.
8 minutes	enters auto power off.	Press any button (or insert/remove a card).
3 hours	turns off.	Turn Mode dial Off, then back on.

These settings cannot be changed.

Optional AC Adapter

You can purchase an optional Kodak 3-volt AC adapter to power your camera. Use it to save battery power when reviewing and transferring pictures.

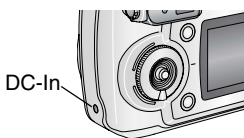

- 1 Connect the AC adapter to the DC-In port.
- 2 Connect the other end of the AC adapter to an electrical outlet.

For batteries and AC adapters, visit www.kodak.com/go/cx6445accessories.



CAUTION:

Do not use the optional 3-volt AC adapter with the Kodak EasyShare camera dock 6000. It is NOT compatible.

FCC Compliance and Advisory

Kodak EasyShare CX6445 zoom digital camera Tested to comply with FCC Standards. FOR HOME OR OFFICE USE
--

This equipment has been tested and found to comply with the limits for a Class B digital device, pursuant to Part 15 of the FCC Rules. These limits are designed to provide reasonable protection against harmful interference in a residential installation.

This equipment generates, uses, and can radiate radio frequency energy and, if not installed or used in accordance with the instructions, may cause harmful interference to radio communications. However, there is no guarantee that interference will not occur in a particular installation.

If this equipment does cause harmful interference to radio or television reception, which can be determined by turning the equipment off and on, the user is encouraged to try to correct the interference by one or more of the following measures: 1) reorient or relocate the receiving antenna; 2) increase the separation between the equipment and the receiver; 3) connect the equipment to an outlet on a circuit different from that to which the receiver is connected; 4) consult the dealer or an experienced radio/TV technician for additional suggestions.

Any changes or modifications not expressly approved by the party responsible for compliance could void the user's authority to operate the equipment. Where shielded interface cables have been provided with the product or specified additional components or accessories elsewhere defined to be used with the installation of the product, they must be used in order to ensure compliance with FCC regulation.

Canadian DOC Statement

DOC Class B Compliance—This Class B digital apparatus complies with Canadian ICES-003.

Observation des normes-Class B—Cet appareil numérique de la classe B est conforme à la norme NMB-003 du Canada.

Index

A

A/V out, iii, 52, 63

AC adapter

3-volt, camera, 107

5-volt, camera dock, 73

accessories

AC adapter, camera, 107

battery, 13

buying, 95

camera dock, 71

printer dock, 70

SD/MMC card, 9

adjusting

screen display, 5

viewfinder, diopter dial, 19

advanced digital zoom, 20, 62

albums, tagging

in review mode, 50

pictures, 35

videos, 42

alkaline batteries, warning, 4

auto

flash, 21

focus framing marks, 18

focus sensor, i

mode, 16

power-down, 107

B

batteries

alkaline warning, 4

capacities, 12

charge via camera dock, 76

door location, iv

expected life, 12

extending life, 13

loading, 4, 74

replacement types, 12

safety, 13

black & white pictures, 29

burst

button, ii

taking a series, 24

button

delete, ii, 19

flash/status, iv, 21

menu, ii

OK, ii, 5

on/off, ii

review, ii, 45

self timer/burst, iv, 24

Share, ii, 55

shutter, i, iv
zoom, ii, 20

C

cable

audio/video, 3, 52
power, camera dock, 73
USB, 3, 69, 73

camera dock

camera compatibility, 80
charging battery, 76
connection, 73
connector on camera, iv
docking camera, 75
installing custom insert, 72
lights status, 77
package contents, 71
reviewing pictures, 78
specifications, 78
troubleshooting, 79

camera overviews, i—iv

camera screen

adjusting display, 5
error messages, 88
liveview, 17
reviewing pictures/videos, 45
status area, 7
status icons, 8
turning off liveview, 61

using as viewfinder, 17

Canadian compliance, 108

card, memory, 106

caring for your camera, 103

changing

picture taking mode, 16
storage location, 10

charging battery via camera
dock, 76

charging lights, camera dock, 76

checking

camera status, settings, 7
storage setting, 11

cleaning camera, lens, 103

clock, setting, 6

close-up mode, 16

color mode, 29

computer

connecting camera, 69
connecting camera dock, 73
installing software, 66
transfer to, 69, 77

connecting

camera dock, 73
camera to camera dock, 75
camera to computer, 69

contents, package

camera, 3
camera dock, 71

- copy pictures
 - card to memory, 53
 - to computer via camera, 69
 - to computer via camera dock, 77
- CRV3 battery, installing, 4
- custom insert, 72
- customer support, 96
- customizing camera settings, 59
- D**
- date
 - displaying on video, 54
 - imprinting on pictures, 36
 - setting, 6
- DCIM folder, card, 105
- DC-in, iii, 107
- default settings, original, 102
- delete button, ii
- deleting
 - by formatting, 64
 - during quickview, 19, 40
 - from internal memory, 47
 - from SD/MMC Card, 47
 - protected pictures/videos, 49
- digital zoom
 - changing, 62
 - using, 20
- diopter dial, ii, 19
- disposal, recycling, 104
- dock
 - camera, 71
 - printer, 70
- downloading pictures, 69, 77
- E**
- EasyShare software, 65
- emailing pictures, videos, 57
- error messages, camera screen, 88
- exposure
 - compensation, 27
 - long time, 32
 - metering, 33
- external video device
 - setting video out, 63
 - viewing pictures, videos, 52
- F**
- favorites, tagging, 58
- FCC compliance, 108
- file names, card, 106
- fill flash, 21
- firmware
 - upgrading, 103
 - version, 64
- flash
 - button, ii

- distance range, 21
- settings, 21
- settings per mode, 22
- unit, i
- flash/status button, ii
- flourescent light, 30
- focus
 - distances, close-up mode, 16
 - distances, specifications, 100
 - framing marks, 18
 - zone, 34
- folders, card, 105
- formatting, internal
 - memory/card, 64
- framing your picture, 18
- G**
- guidelines, battery, 13
- H**
- help
 - camera dock, 79
 - technical support, 95
 - web links, 95
- I**
- icons
 - camera screen, 8
 - mode dial, 16
 - picture taking modes, 16
 - review menu, 48
 - setup menu, 59
 - Share menu, 55
- image storage menu, 10
- indoor pictures, tungsten light, 30
- information
 - about camera, 64
 - about pictures/videos, 54
- insert, custom/universal, 72
- installing
 - batteries, 4
 - custom insert, 72
 - rechargeable battery, 74
 - SD/MMC card, 9
 - software, 66
- internal memory
 - formatting, 64
 - setting storage location, 10
 - storage capacity, 104
- ISO speed, 31
- J**
- joystick, ii
- K**
- Kodak EasyShare software
 - getting help, 95

- installing, 66
- upgrading, 103

Kodak web sites, 95

L

- landscape mode, 16
- language, setting, 63
- LCD (liquid crystal display). *See* camera screen

lens

- cleaning, 103
- location, i

light

- camera dock, 76, 77
- ready, camera, ii, 92
- self timer, i, 23, 43
- sensor, i
- video record, i

- lighting conditions, using white balance, 30

liveview

- camera screen as viewfinder, 17
- turning default on, 61
- turning on/off, 17

loading

- batteries, 4, 74
- SD/MMC card, 9
- software, 66

- locator for dock, iv
- long time exposure, 32

M

Macintosh

- installing software on, 67
- magnify picture, 48
- maintenance, camera, 103
- matrix metering, 33
- memory
 - inserting card, 9
 - internal, 9, 10
 - removeable card, 10
 - storage capacities, 104
 - storage location setting, 10

menu

- button, ii
- review mode, 48
- setup mode, 59
- Share mode, 55
- still modes, 25—26
- video mode, 41

microphone, i

- MISC folder, card, 105

- mode dial, ii, 16

modes, picture taking

- available shutter speeds, 101
- flash settings, 22
- menu options, 25—26

- overview, 16
- movies. *See* video
- multiple pictures, viewing, 46
- N**
- night mode, 16
- Ni-MH rechargeable battery, installing, 74
- NTSC, video out setting, 63
- O**
- OK button, ii, 5
- online prints, ordering, 70
- optical zoom, 20, 41
- orientation sensor, 37
- overview
 - camera, ii
 - camera modes, 16
 - picture taking modes, 16
- P**
- package contents
 - camera, 3
 - camera dock, 71
- PAL, video out setting, 63
- pictures
 - checking location, 11
 - copying, 53
 - date imprint, 36
 - deleting, 47
 - emailing tagged, 57
 - file naming, 106
 - locating on card, 105
 - magnifying, 48
 - printing, 70
 - printing tagged, 56
 - protecting, 49
 - quality, setting, 28
 - reviewing, 45
 - reviewing, camera dock, 78
 - storage capacity, 105
 - tagging, 35, 50
 - taking, 15
 - taking, modes, 16
 - transfer via camera, 69
 - transfer via camera dock, 77
 - viewing multi-up, 46
 - viewing on television, 52
- playing a video, 46
- portrait mode, 16
- power
 - auto off, 107
 - camera, 5
 - camera dock, 73
 - on/off, ii
- printer dock, 70
- printing
 - 4 x 6 prints, 28

- changing default quantity, 60
 - from a card, 70
 - optimizing printer, 95
 - order online, 70
 - pictures, 70
 - tagged pictures, 56, 70
 - this user guide, 1
 - without a computer, 70
- product overview, ii
- protecting pictures, videos, 49

Q

- quality setting, 28
- quickview
 - turning off, 60
 - using, 19, 40

R

- ReadMe file, 81
- ready light, ii, 92
- recycling, disposal, 104
- red-eye, flash, 21
- regulatory information, 108
- removeable card, 9
- resolution, setting, 28
- review button, ii, 45
- reviewing pictures
 - as you take them, 19
 - camera dock, 78

- camera screen, 45
 - deleting, 47
 - magnifying, 48
 - menu options, 48
 - multi-up, 46
 - protecting, 49
 - slide show, 51
- reviewing videos
 - as you take them, 40
 - camera dock, 78
 - camera screen, 45
 - deleting, 47
 - menu options, 48
 - protecting, 49
 - slide show, 51
- running slide show, 51

S

- safety
 - batteries, 13
 - camera, 103
- screen, camera, ii
- SD/MMC card
 - file names, 106
 - formatting, 64
 - inserting, 9
 - printing from, 70
 - setting storage location, 10
 - slot location, iii

- storage capacities, 104
- self timer
 - button, ii
 - light, i
 - with pictures, 23
 - with videos, 43
- sensor
 - auto focus, i
 - light, i
- sepia tone pictures, 29
- service and support, telephone numbers, 96
- setting
 - date and time, 6
 - flash, 21
 - language, 63
 - picture quality, 28
 - picture taking mode, 16
 - resolution, 28
 - review menu options, 48
 - self timer, 23, 43
 - storage location, 10
 - video out, 63
- setup mode, 59
- Share button, ii, 55
- shutoff, auto, 107
- shutter
 - button, iv
 - problems, 82
 - self timer delay, 23, 43
 - speed, setting, 32
 - speeds, available, 101
 - turn off sound, 62
- sleep mode, 107
- slide show
 - changing display time, 51
 - continuous loop, 52
 - problems, 85
 - viewing on camera, 51
 - viewing on television, 52
- software
 - getting help, 95
 - installing, 66
 - upgrading, 103
- sound, shutter, 62
- speaker, location, iv
- specifications
 - camera, 99
 - camera dock, 78
- sport mode, 16
- status
 - button, ii
 - camera dock lights, 76, 77
 - camera ready light, 92
 - checking on screen, 7
 - screen icons, 8
 - storage location, 11
- storage capacity, 104

strap, wrist, 4
support, technical, 96
system folder, card, 105

T

tagging
 favorites, 58
 for albums, 35, 42, 50
 for email, 57
 for print, 56
 when to tag, 55
taking pictures, 15
taking videos, 39
telephone support, 97
telephoto button, ii
television, slide show, 52
time, setting, 6
timer, shutter delay, 23, 43
tips
 battery guidelines, 13
 maintenance, safety, 103
 ReadMe file, 81
transfer
 via camera, 69
 via camera dock, 77
trash can, deleting, 19, 40
tripod socket, iv
troubleshooting
 camera, 81

 camera dock, 79
 turning camera on and off, 5

U

universal insert, 72
upgrading software,
 firmware, 103
URLs, Kodak web sites, 95
USB (universal serial bus)
 connecting to camera, 69
 connecting to camera
 dock, 73
 connection location, iii
 transferring pictures, 69

V

videos
 checking location, 11
 copying, 53
 date display, 54
 deleting, 47
 emailing tagged, 57
 file naming, 106
 locating on card, 105
 mode, 16
 protecting, 49
 record light, i
 reviewing, 45, 46
 storage capacities, 104

- tagging, 42
- taking, 39
- transfer to computer, 69, 77
- viewing, 45
- viewfinder
 - location, ii
 - using camera screen, 17
- viewing
 - camera information, 64
 - magnified picture, 48
 - picture after taking, 19, 45
 - picture/video
 - information, 54
 - video after taking, 40

W

- white balance, 30
- wide angle button, ii
- Windows
 - installing software, 67
- wrist strap, 4

Z

- zoom
 - button, ii
 - digital, 20, 62
 - optical, still, 20
 - optical, video, 41